



DC COMICS SUPER HEROES

76013



WARNING: CHOKING HAZARD.
Toy contains small parts and a small ball.
Not for children under 3 years.

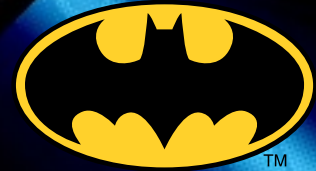

DC
COMICS™

TM



⚠️ AVERTISSEMENT :
RISQUE D'ÉTOUFFEMENT.
Le jouet contient des petites pièces ainsi qu'une petite boule. Il ne convient pas aux enfants de moins de 3 ans.

⚠️ ADVERTENCIA:
PELIGRO DE ASFIXIA.
Juguete que contiene partes pequeñas y una pelota pequeña. No recomendado para niños menores de 3 años.

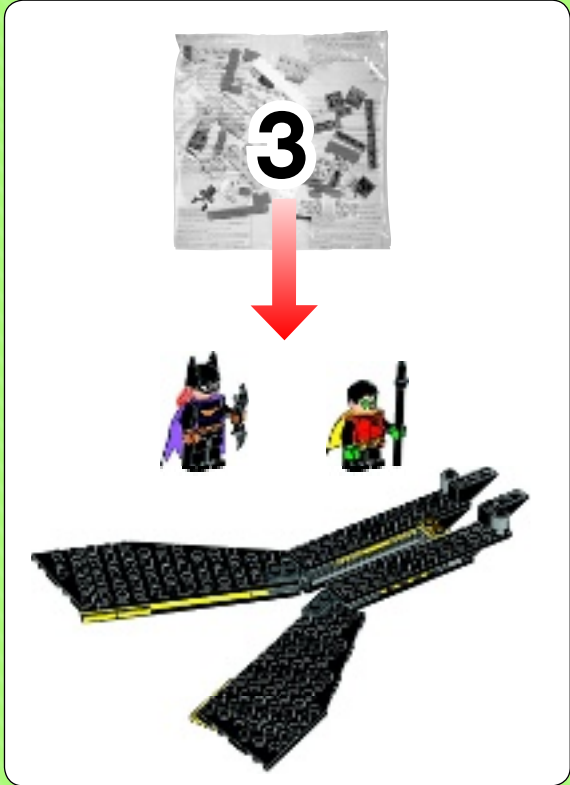



1



2

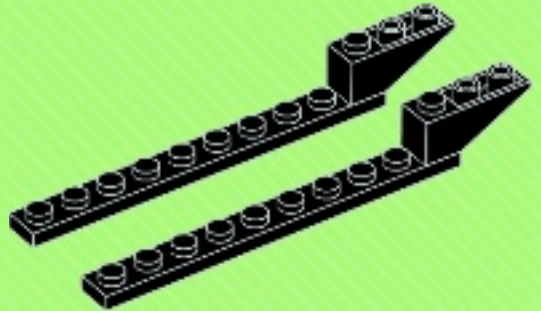

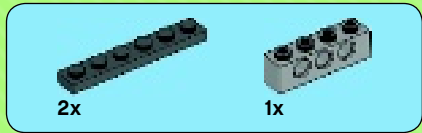

3

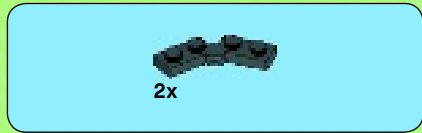
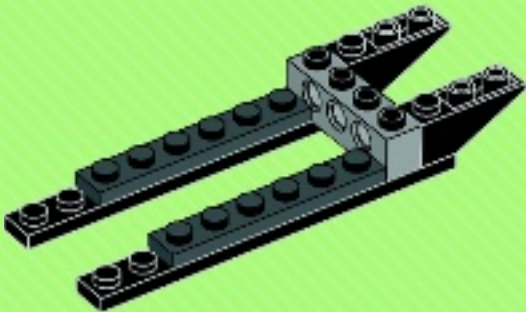

4

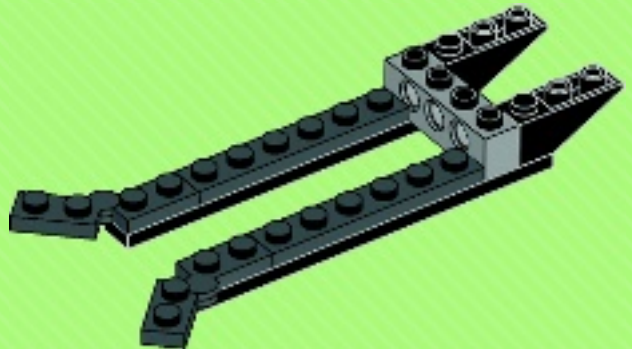

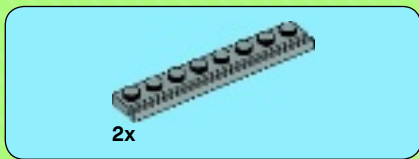

5

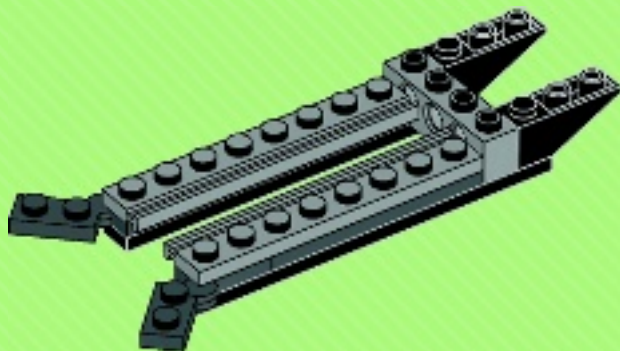



6

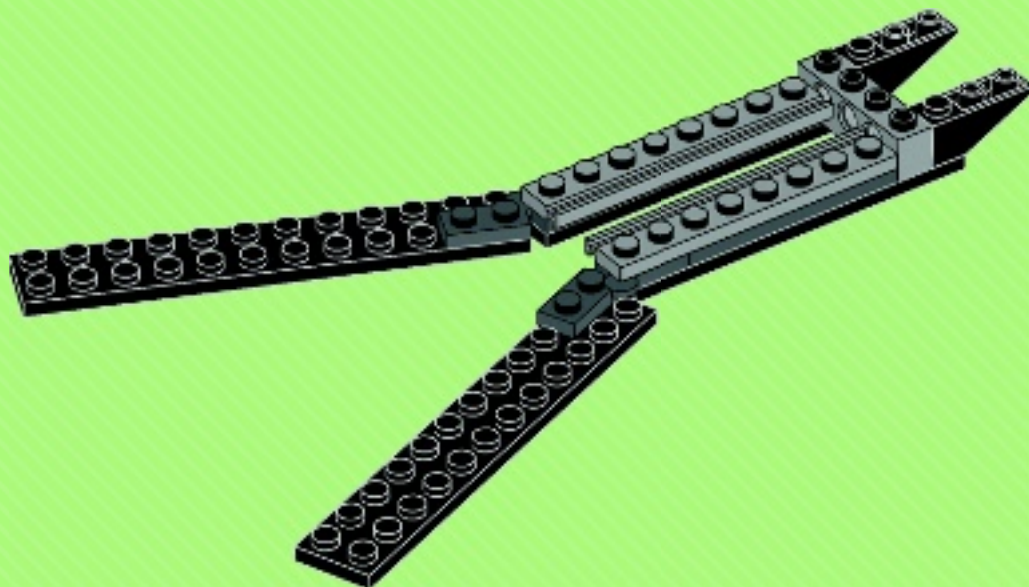



2x



2x

7

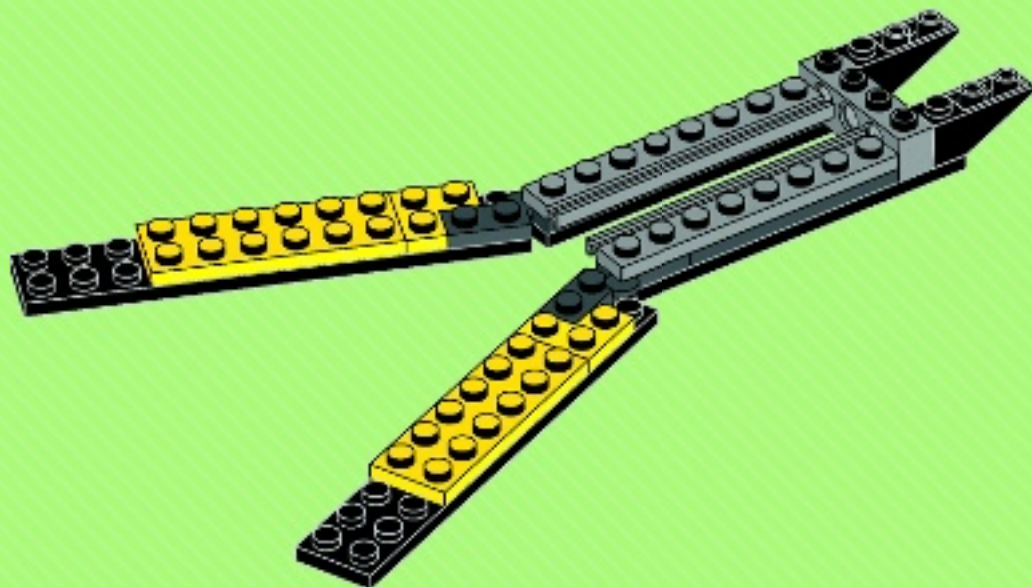



8x

8

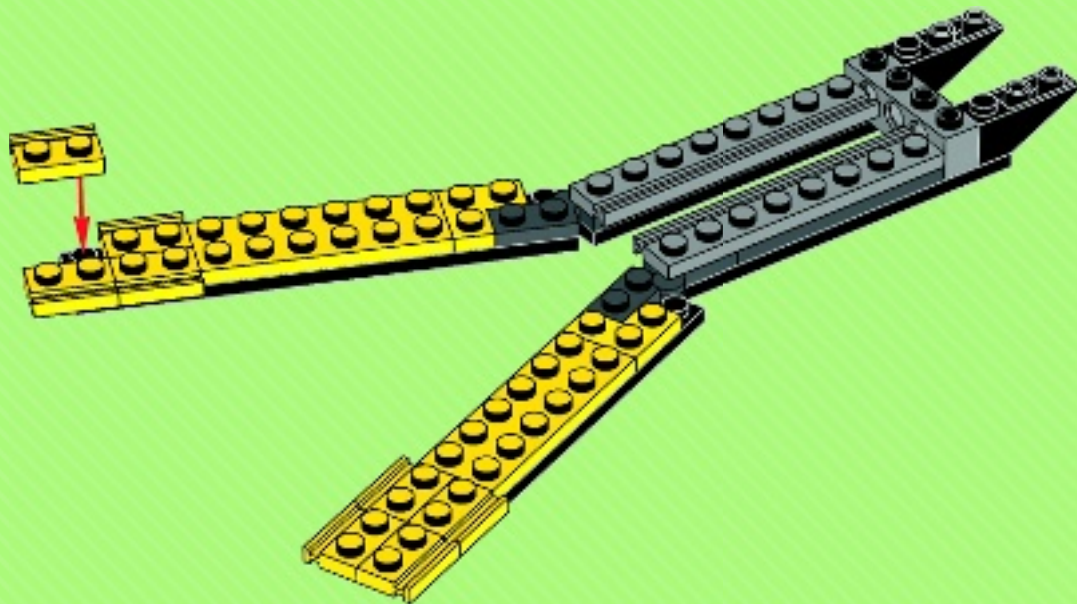

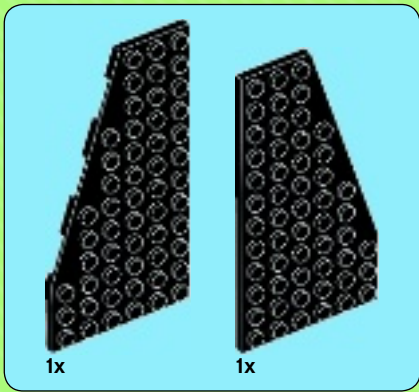

9

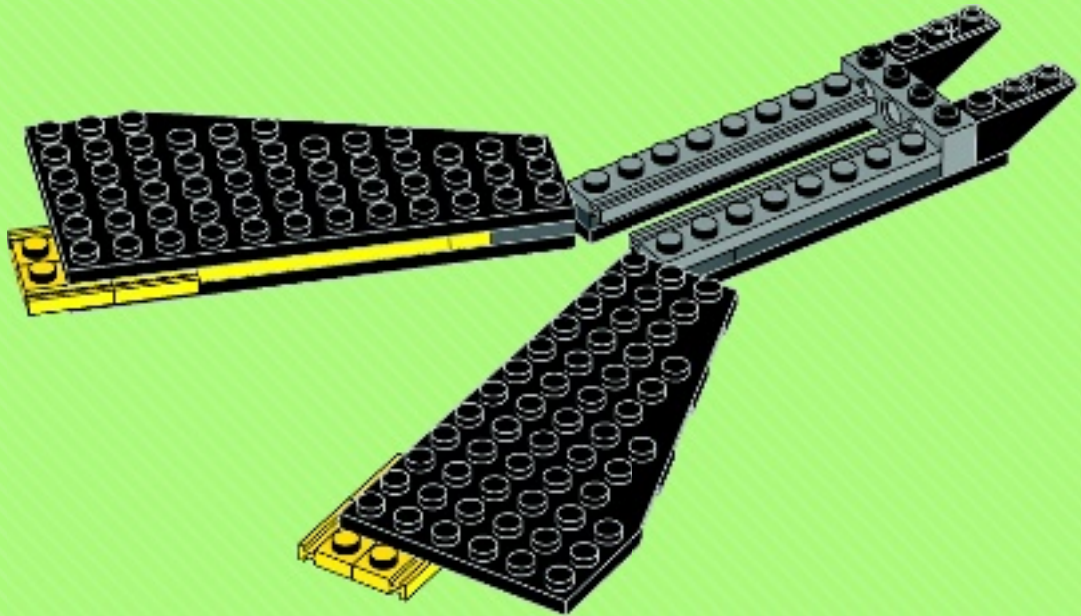



2x



2x

10

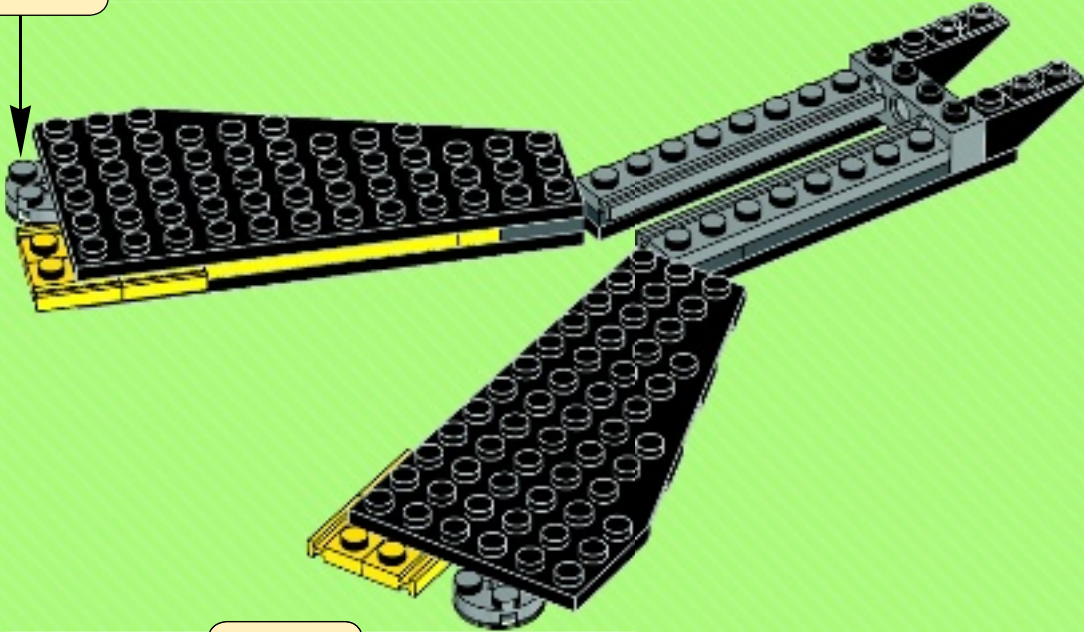

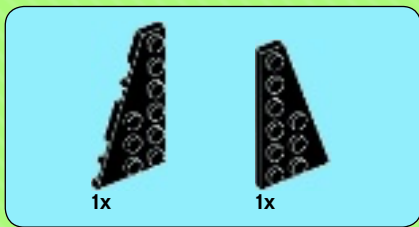

11

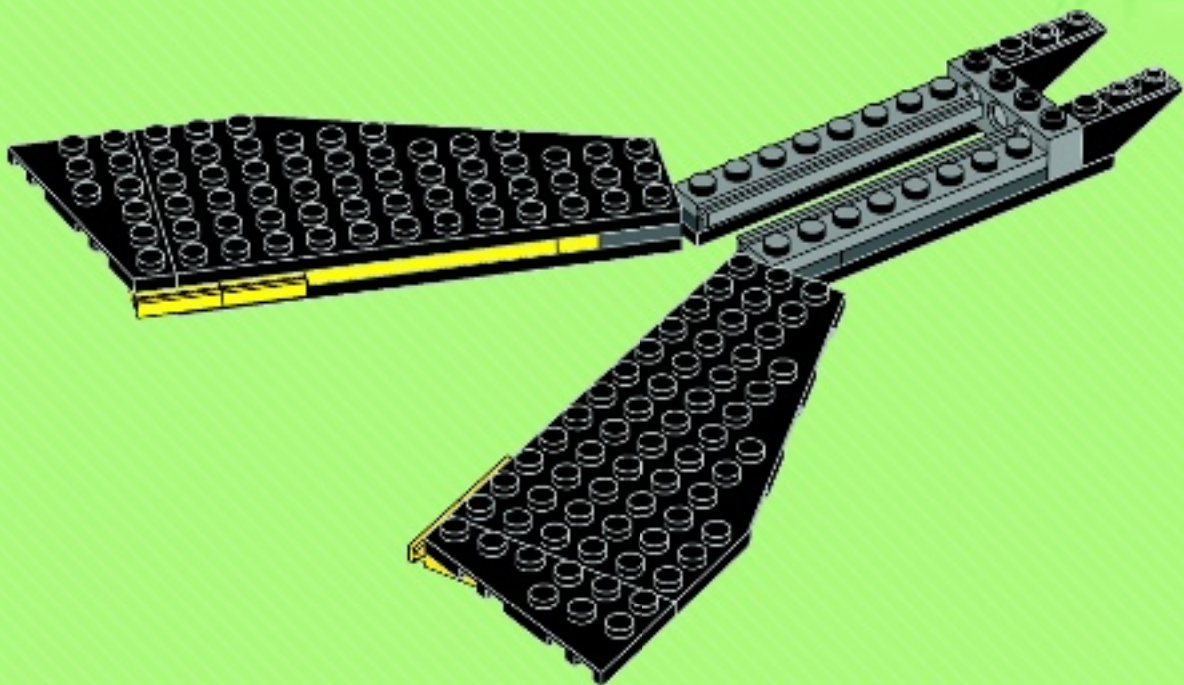



5x



2x

12

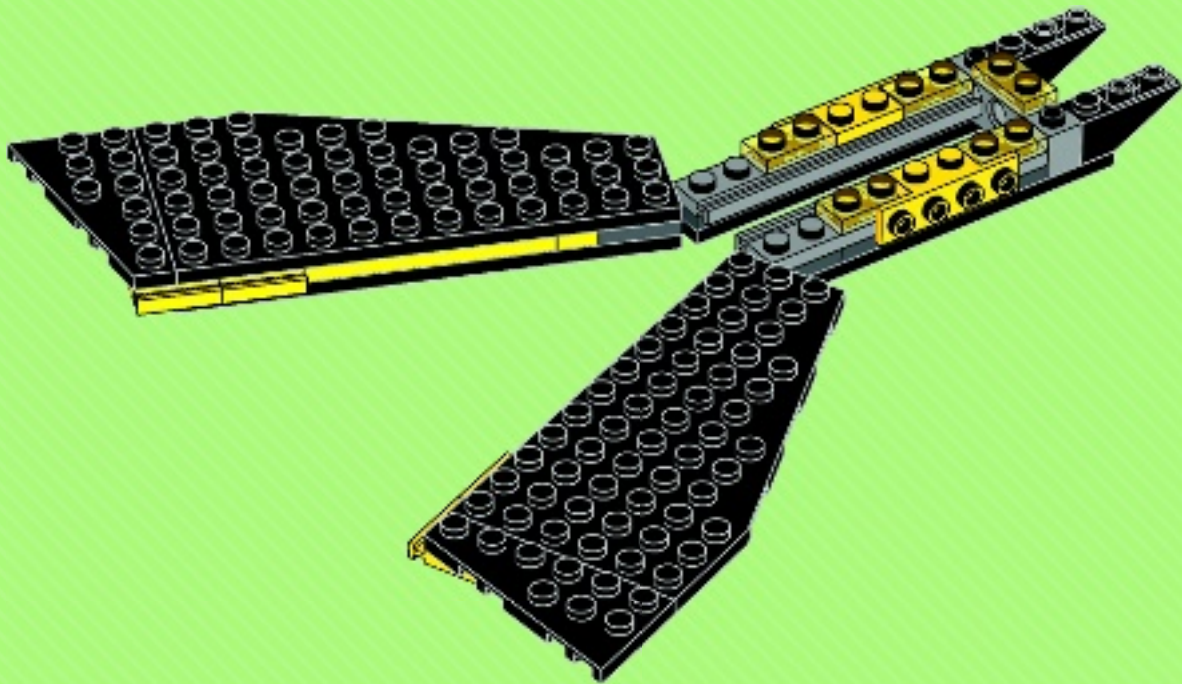



2x

13

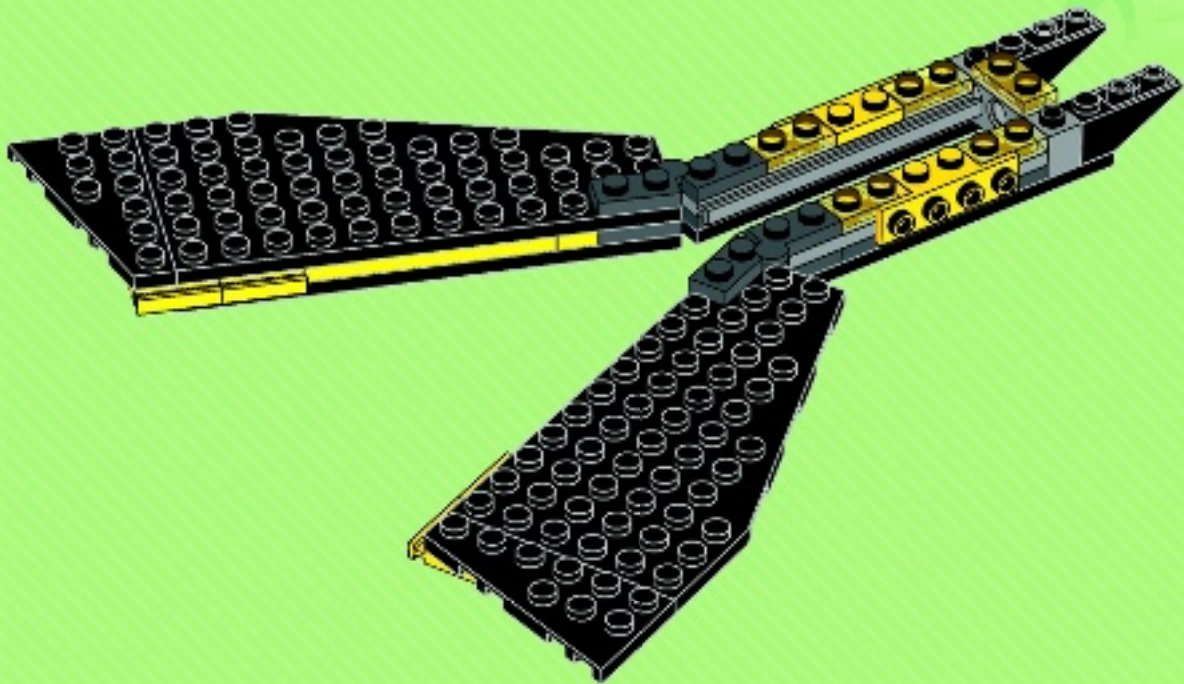

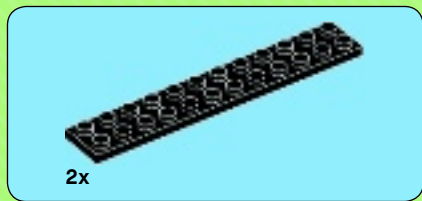

14

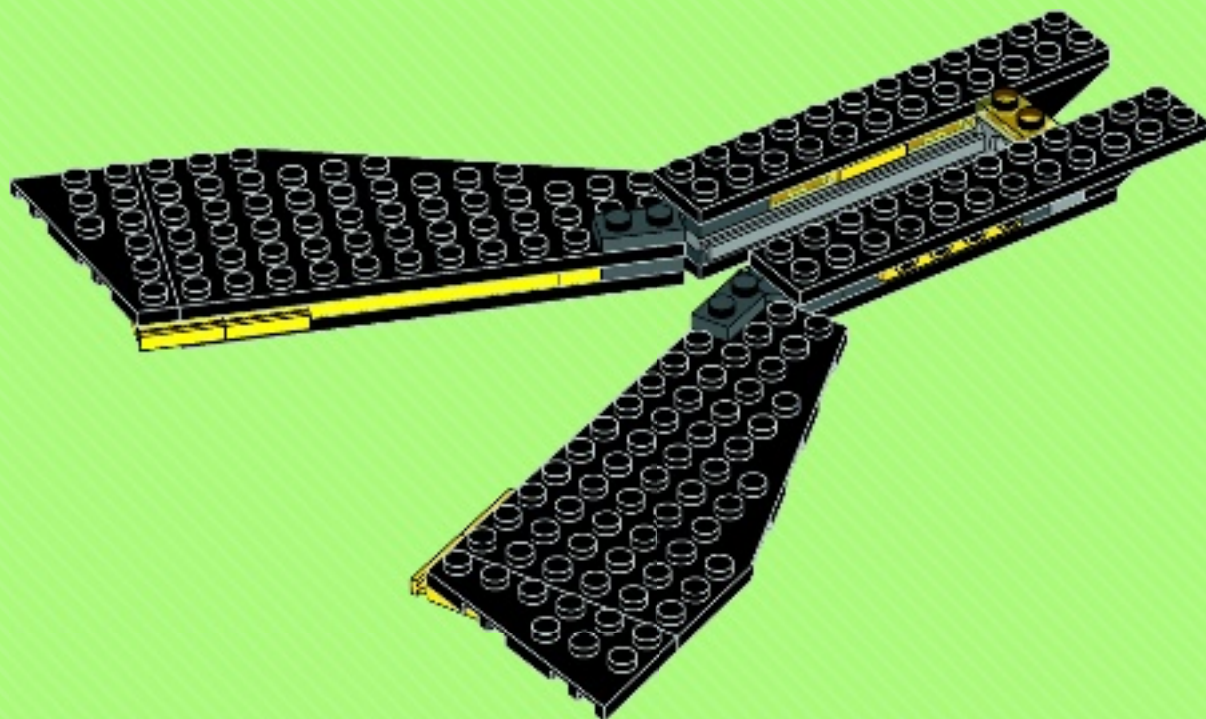



2x



2x

15

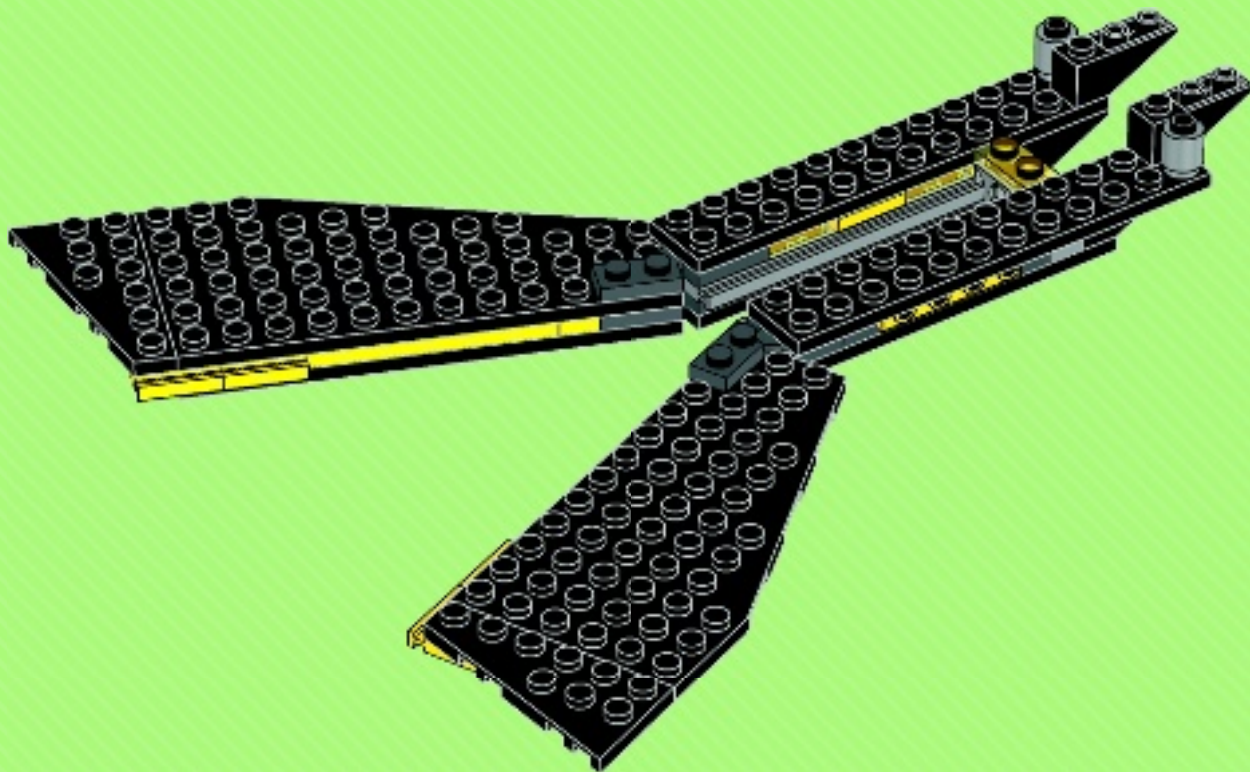

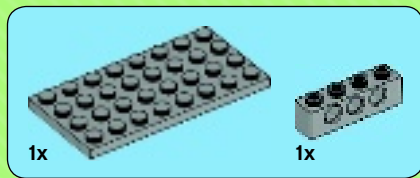

16

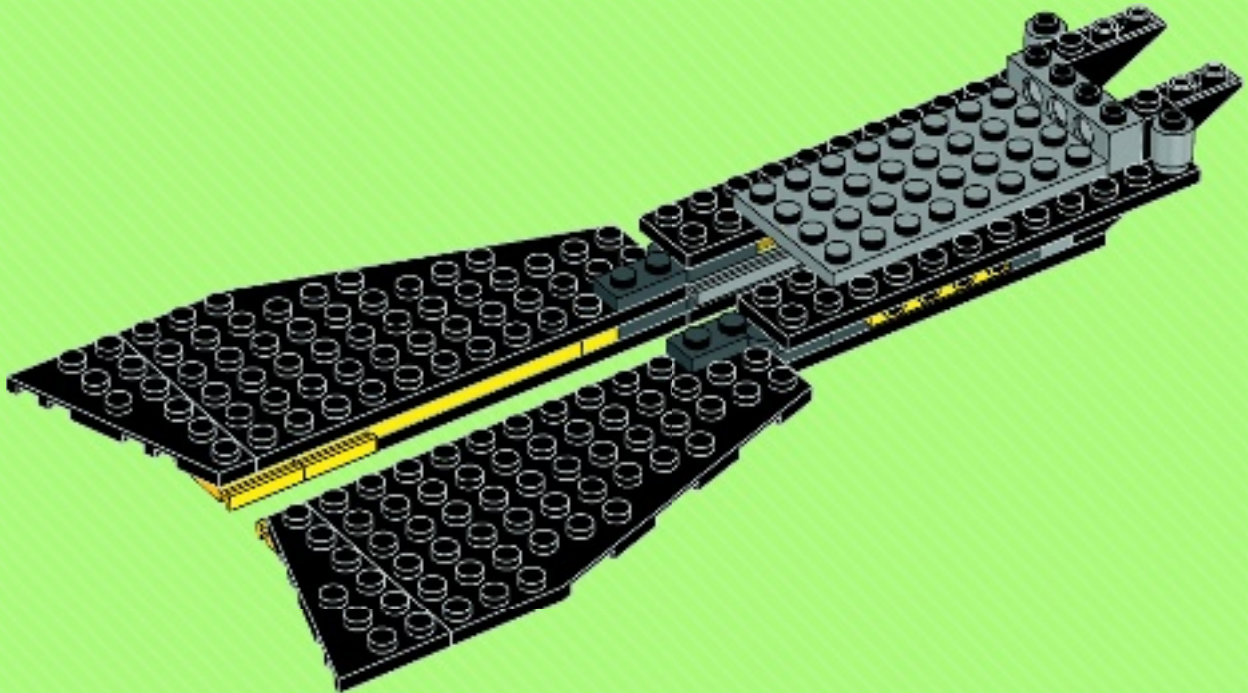



6x

17

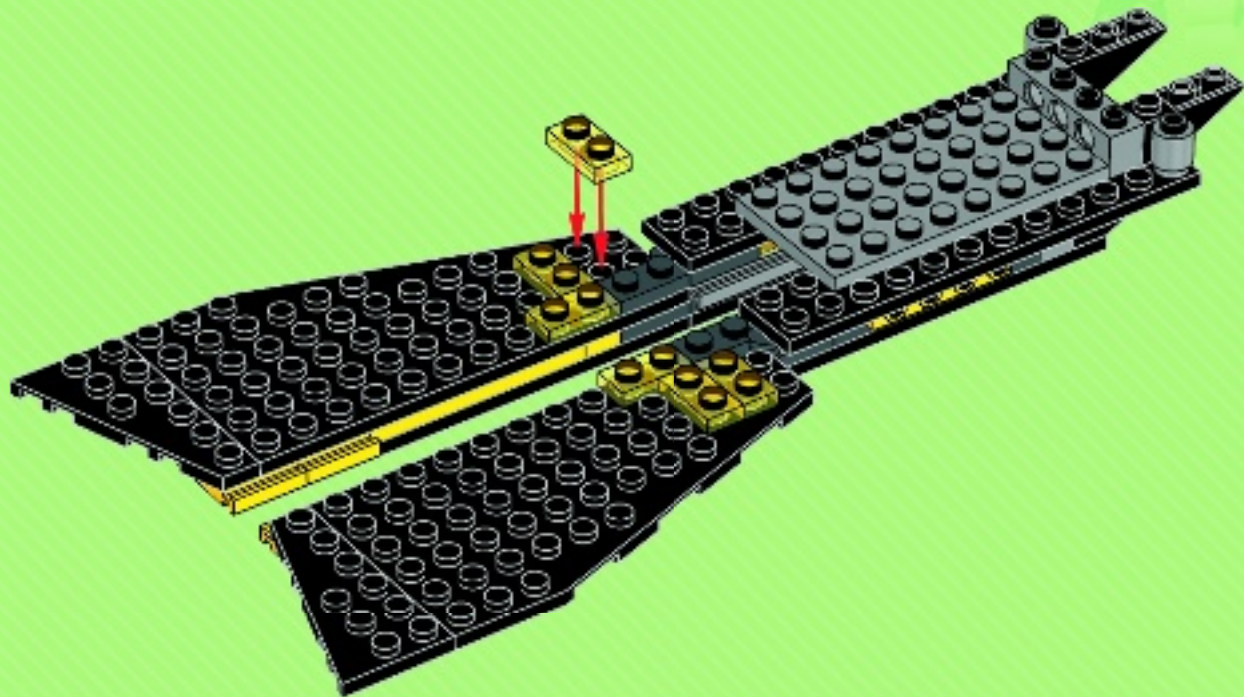



2x



2x

18

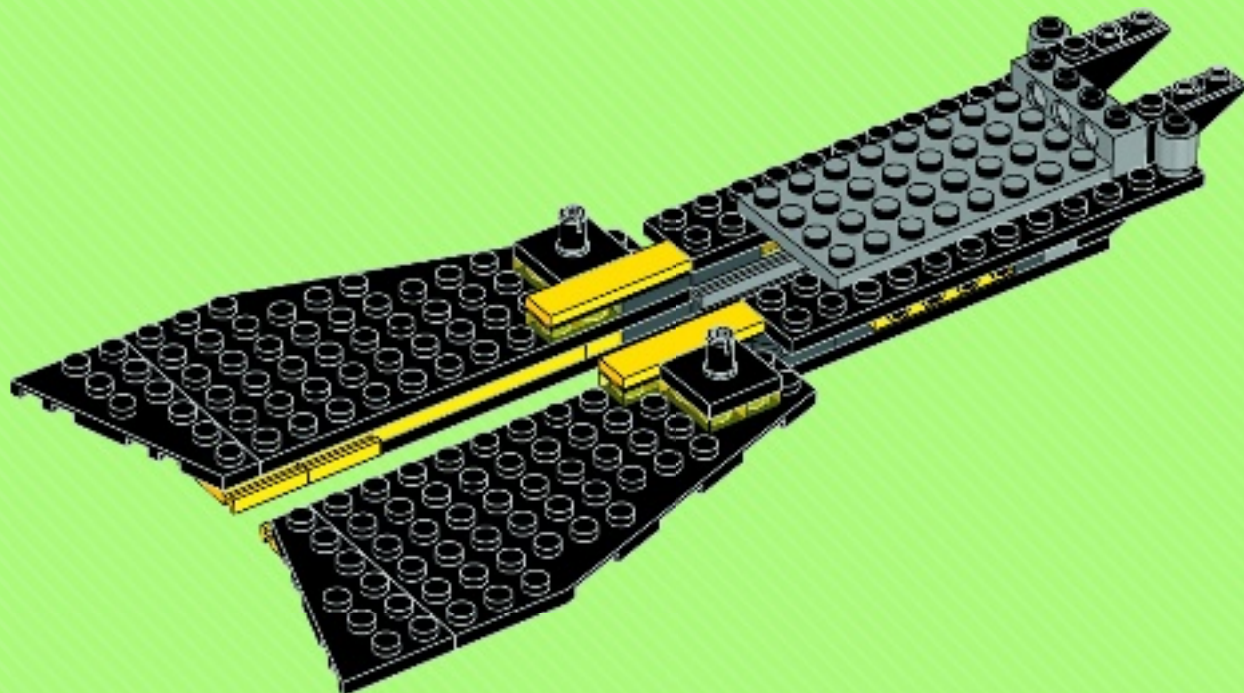



4x



4x

19

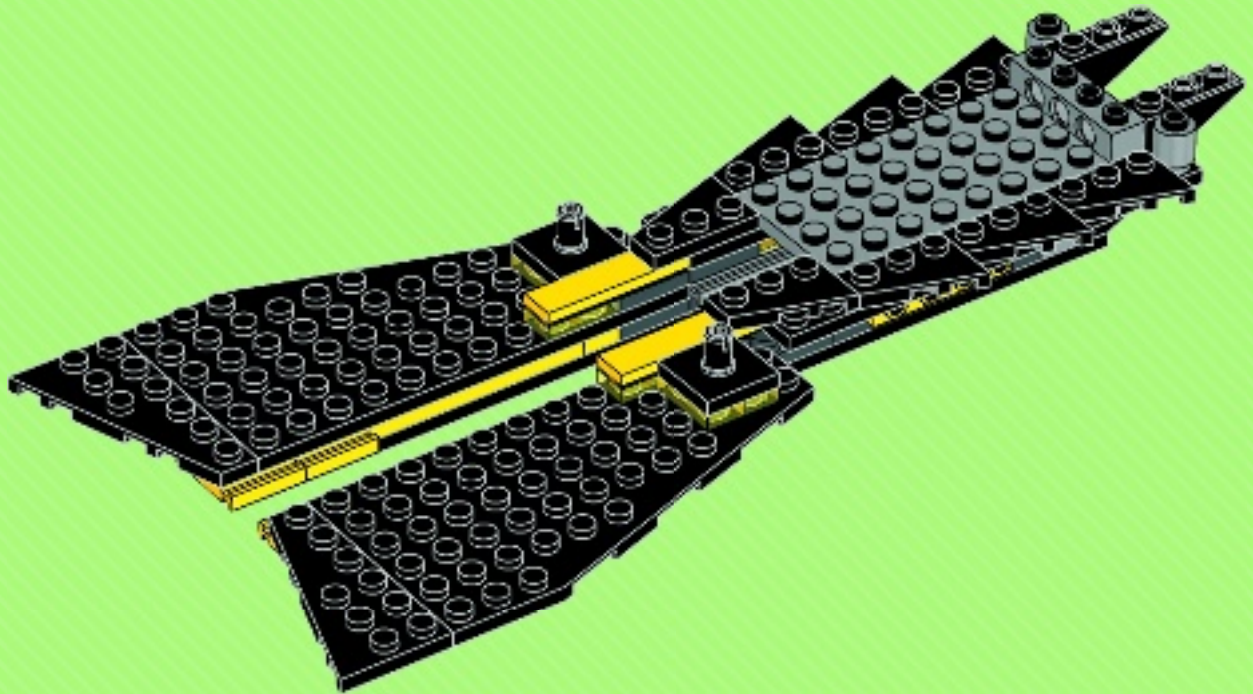



2x



4x

20





21

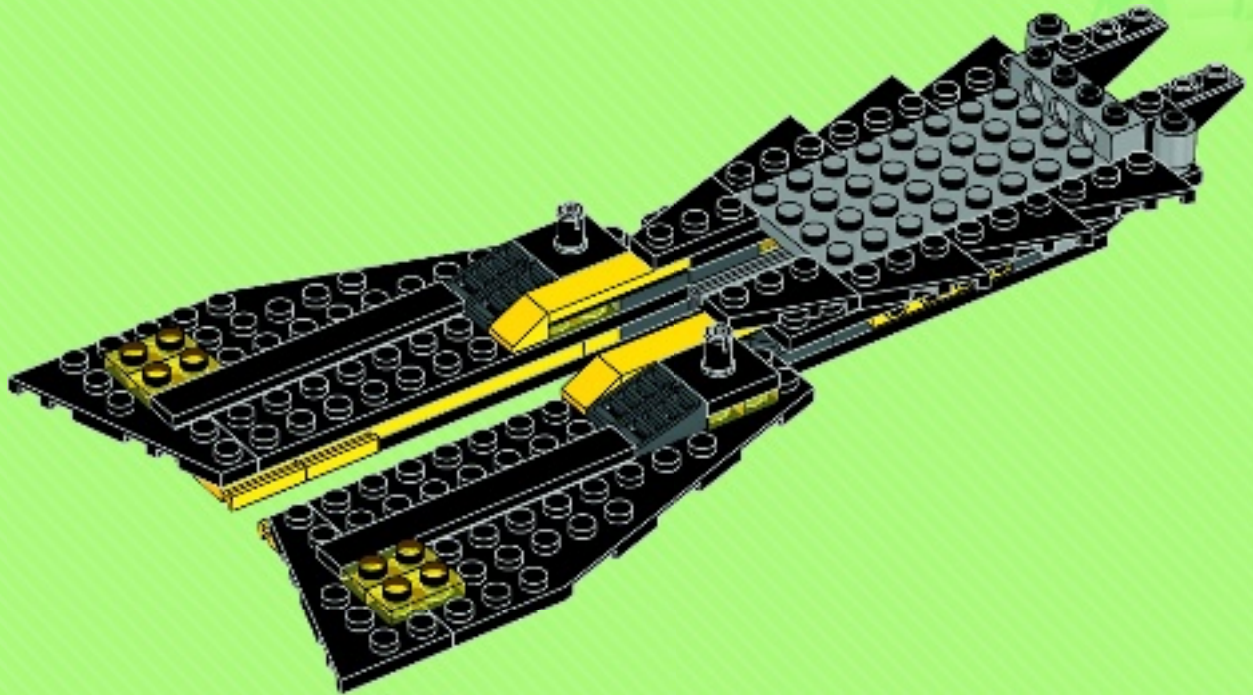



6x

22

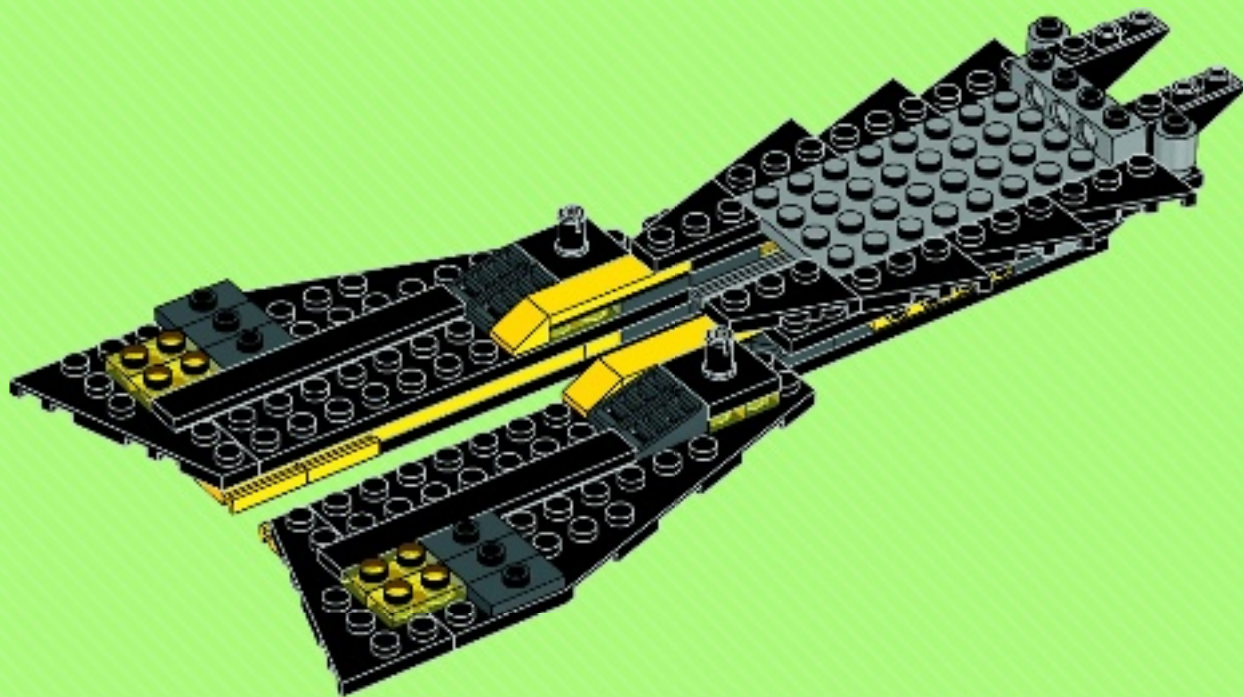



2x



4x



2x

23

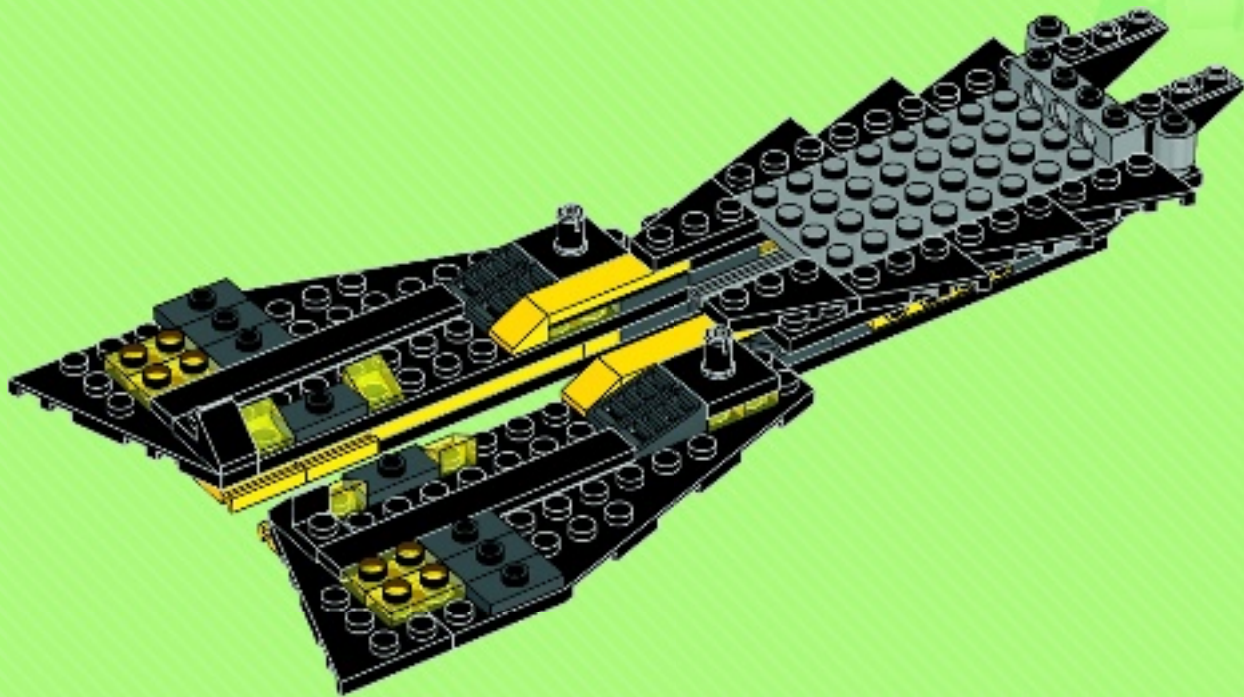



2x



4x

24

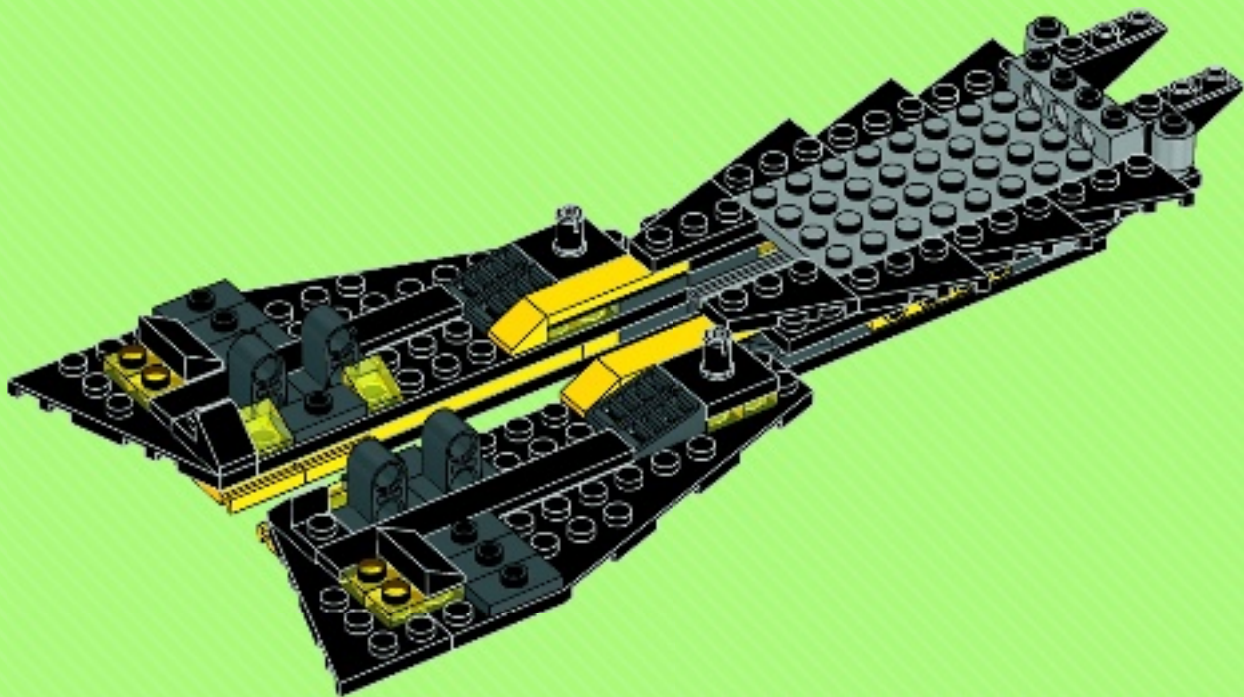



2x

25

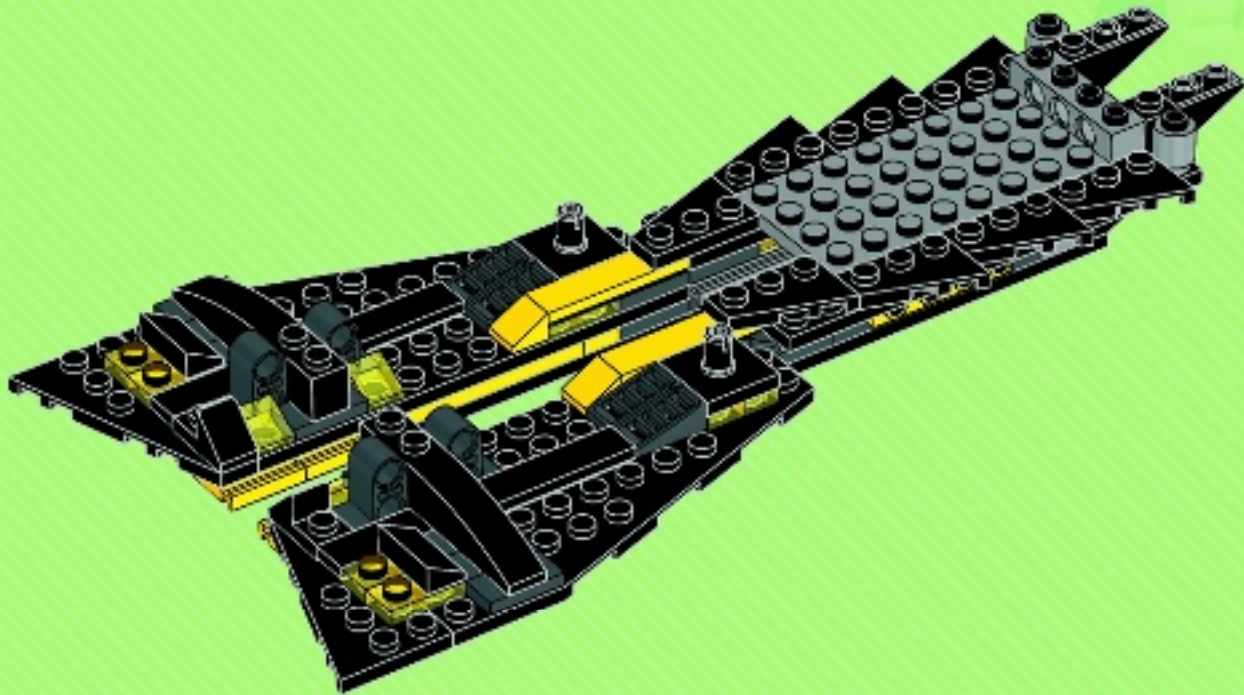

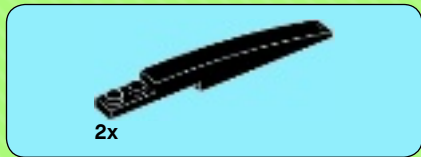

26

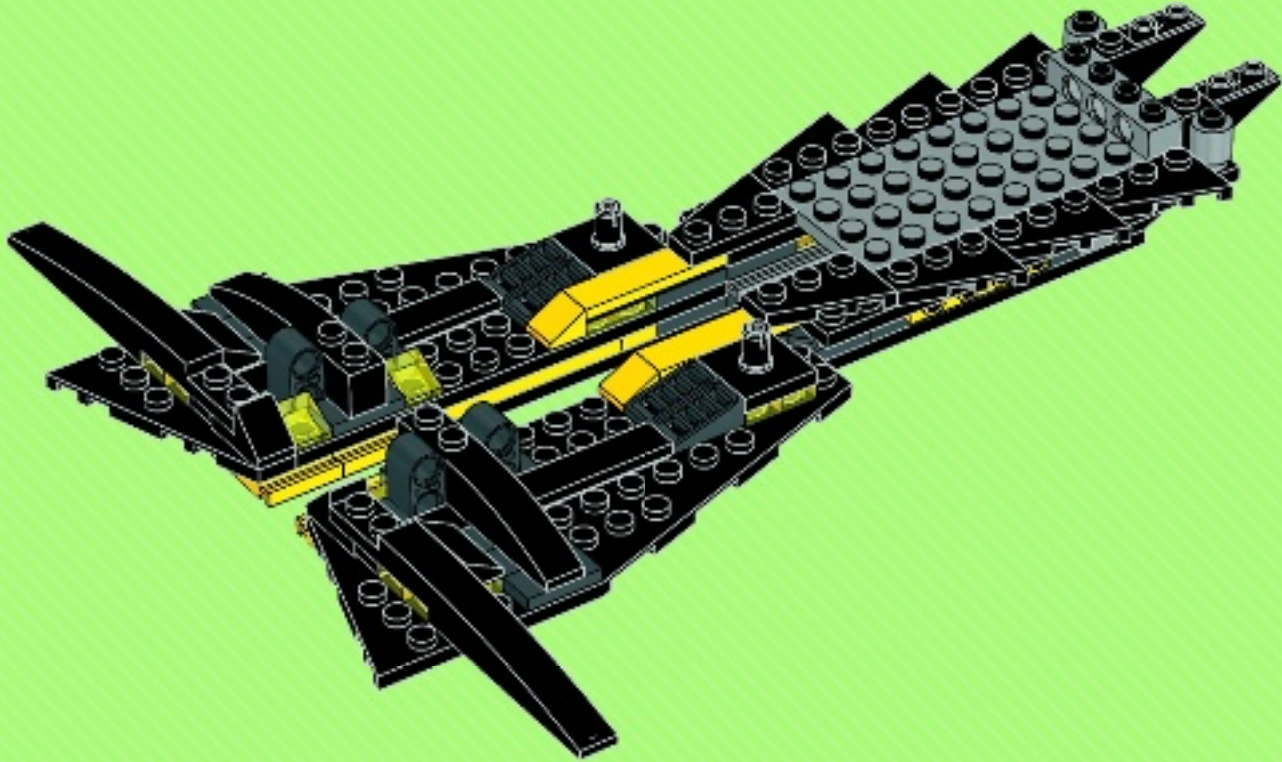



2x



4x

27

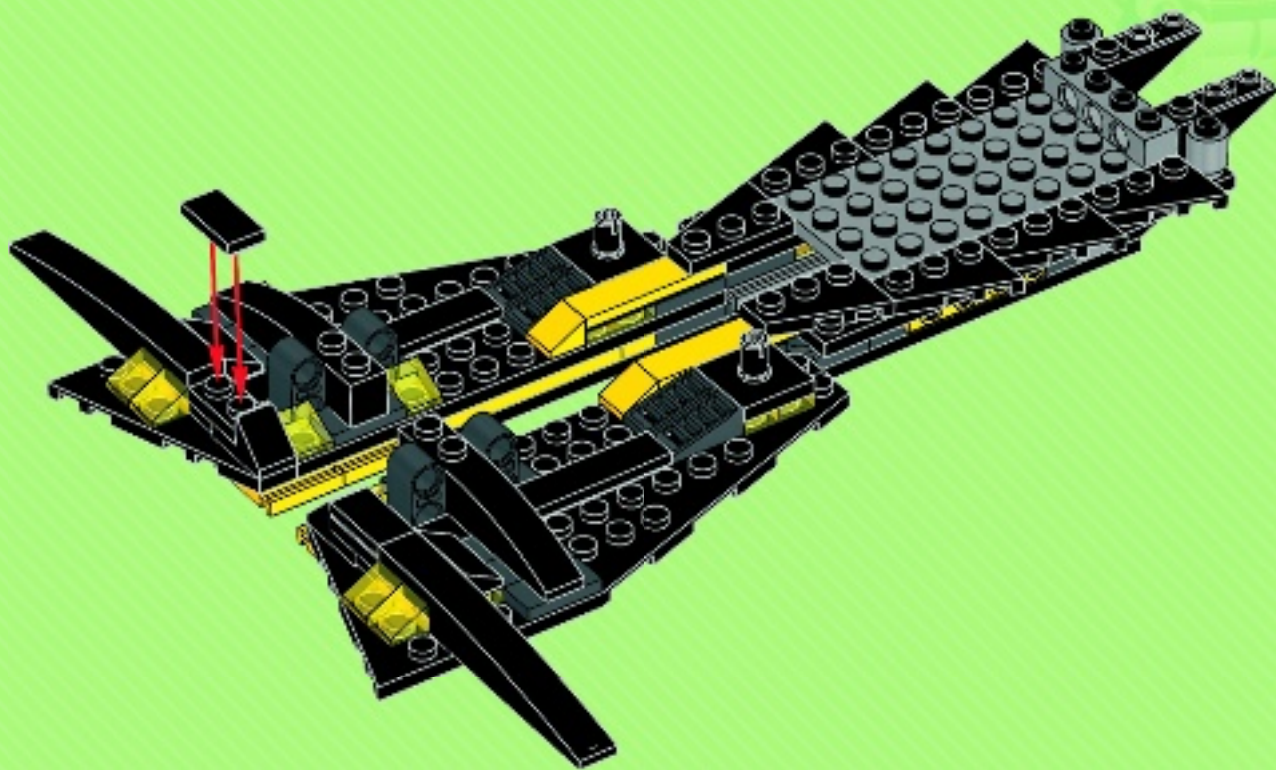



4





2x



1x

28



 1x	 2x	 1x
--	--	--

29

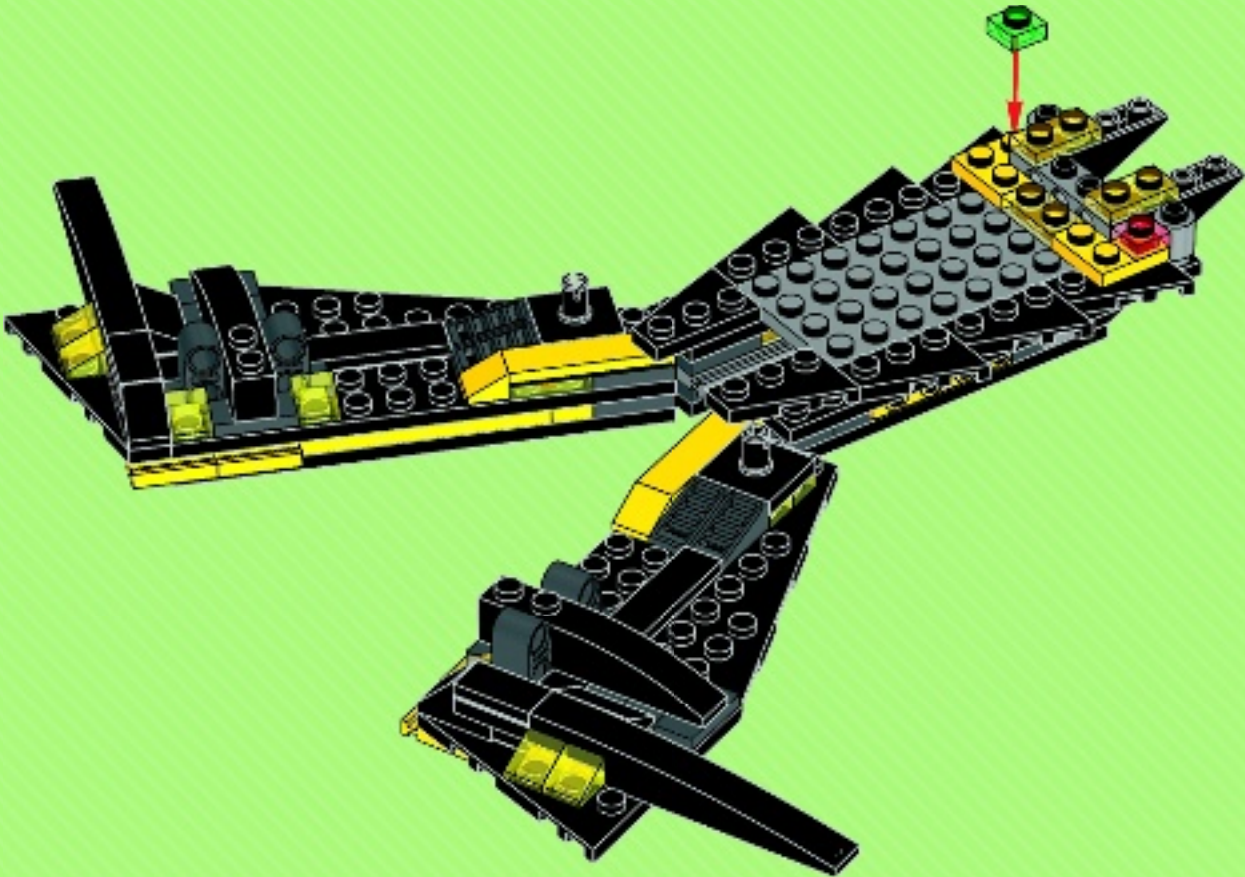

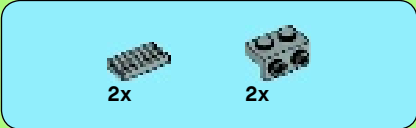

30

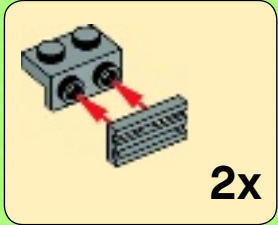

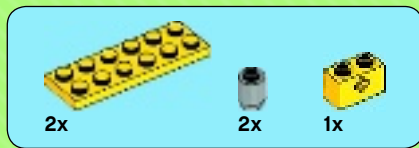

31





1x



2x

32

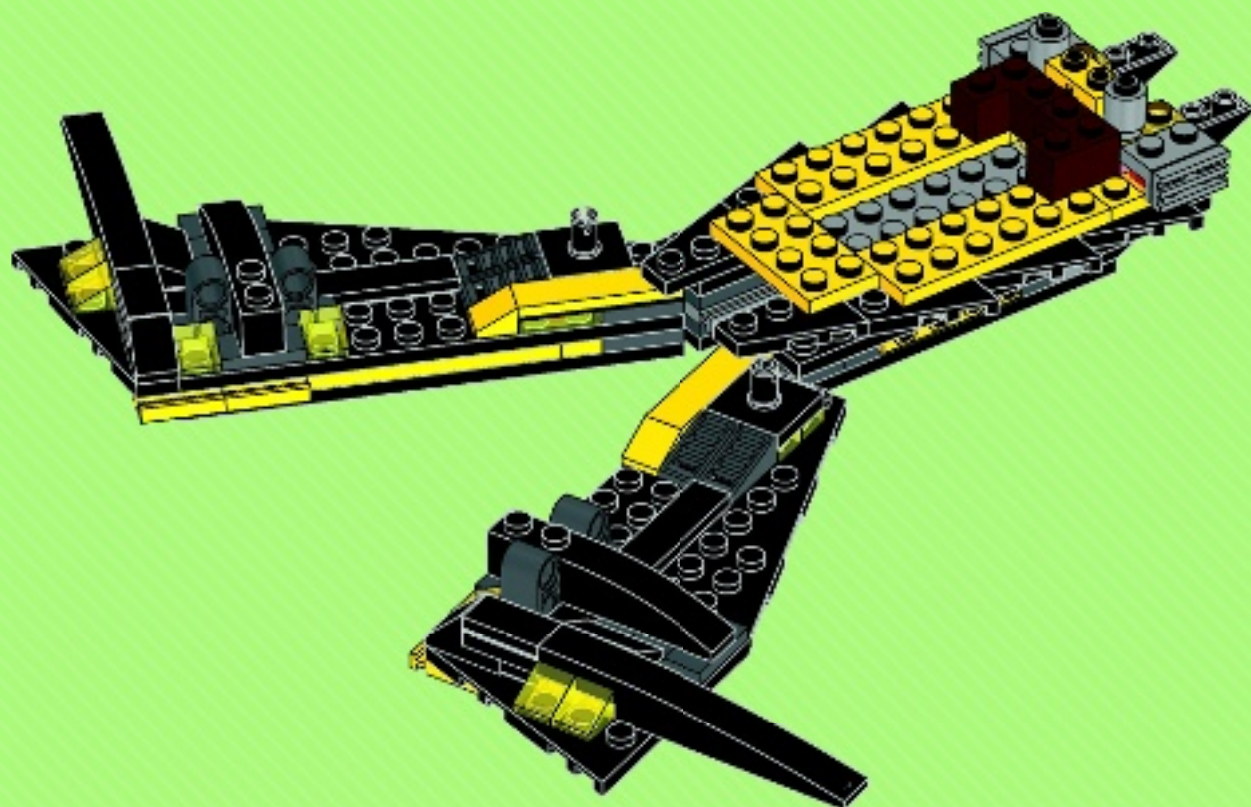

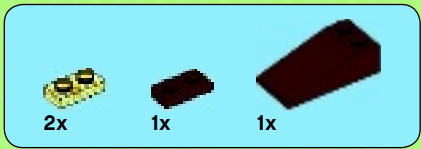

33





2x



2x

34



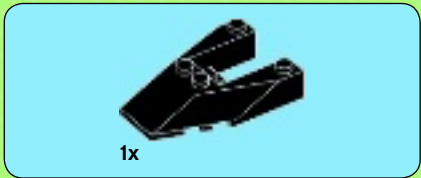

35

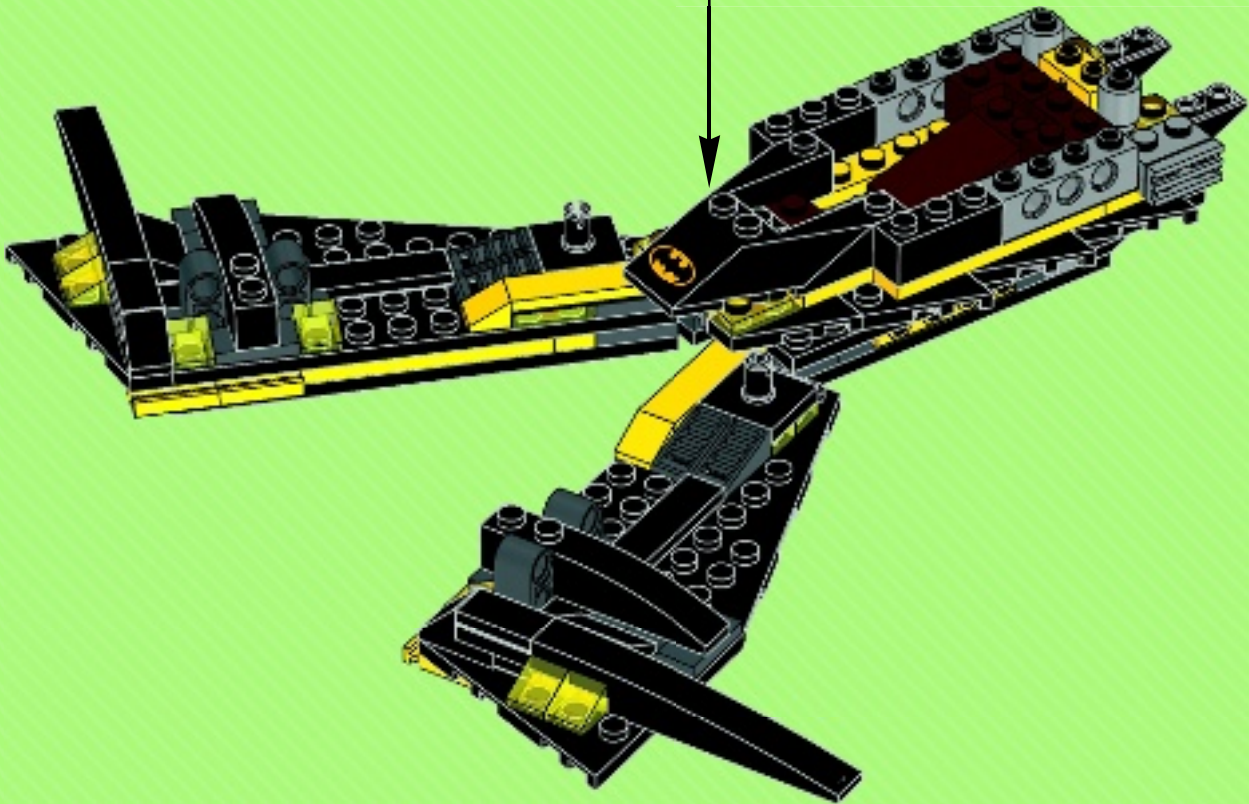
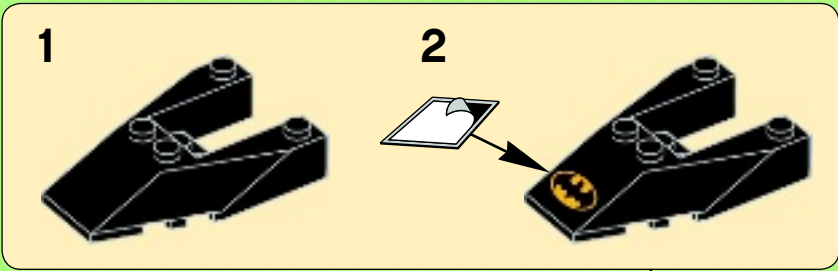

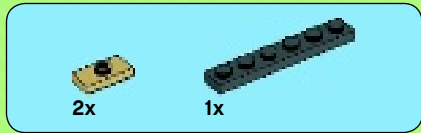

36

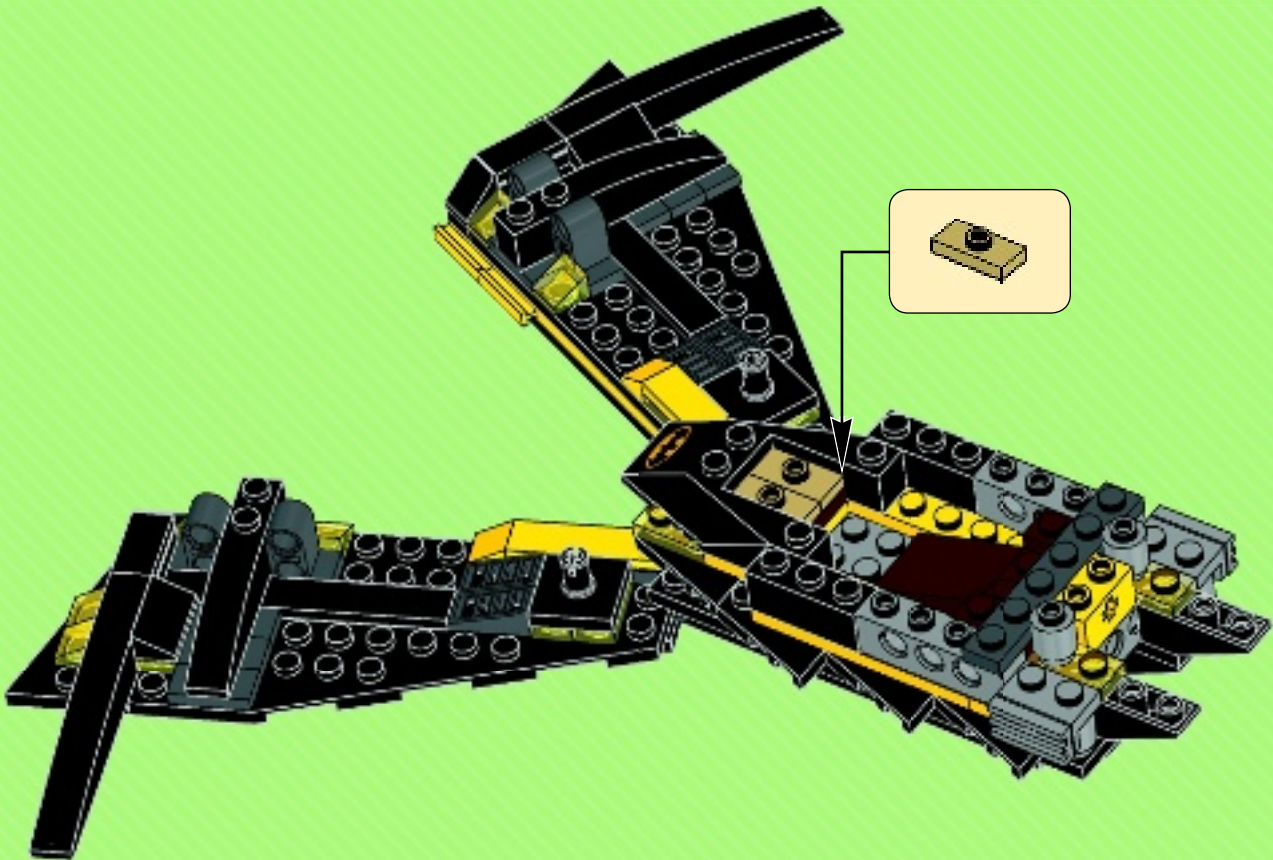



1x



1x



1x

37

1

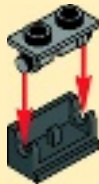

2

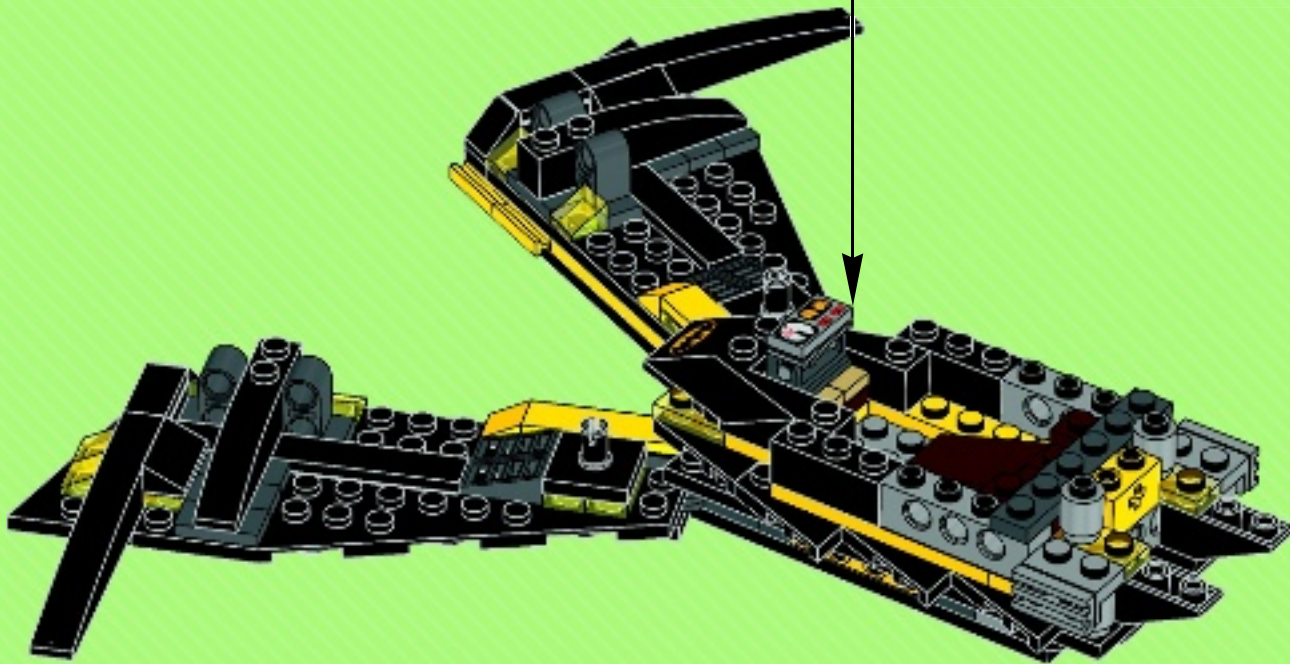



2x



1x



1x

38





2x

39

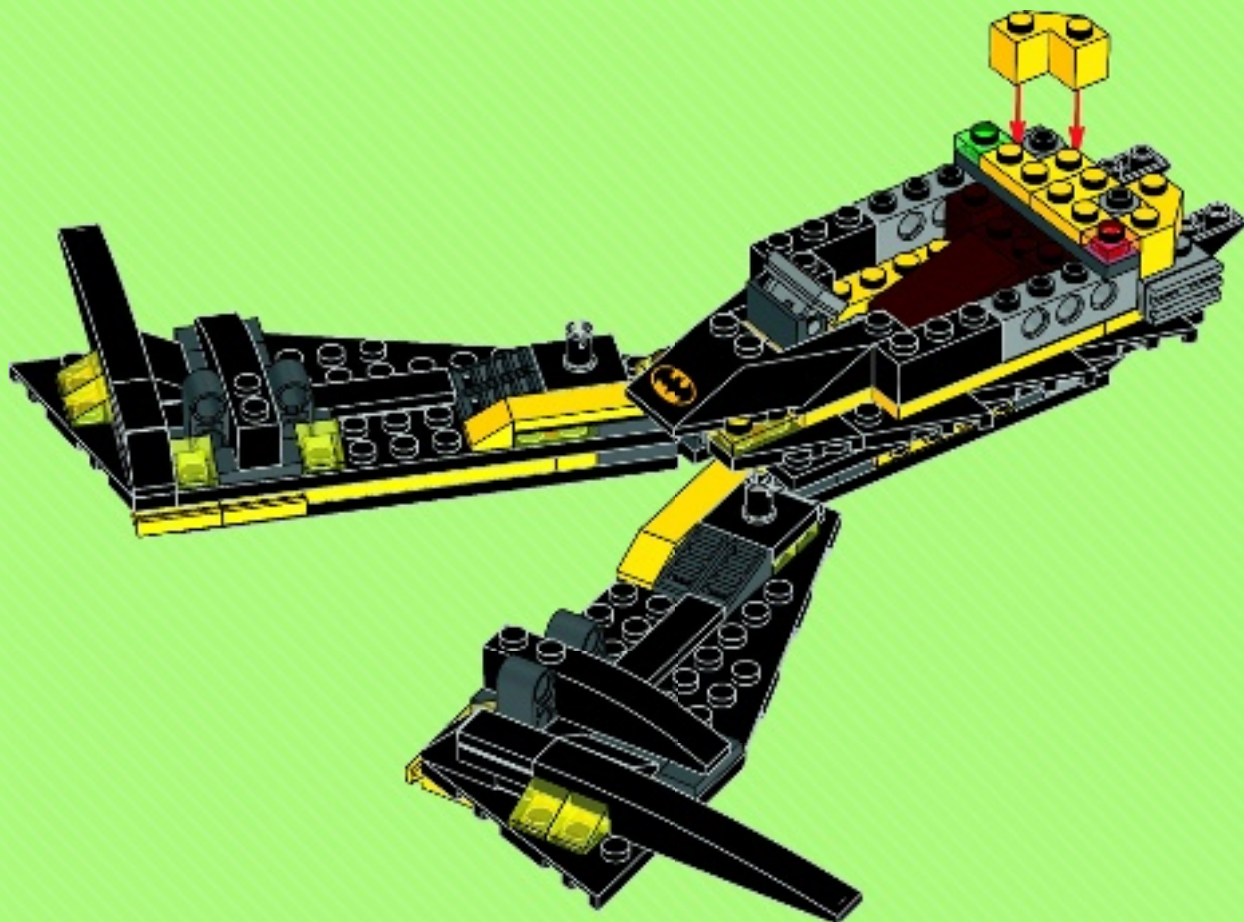

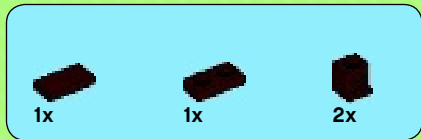

40

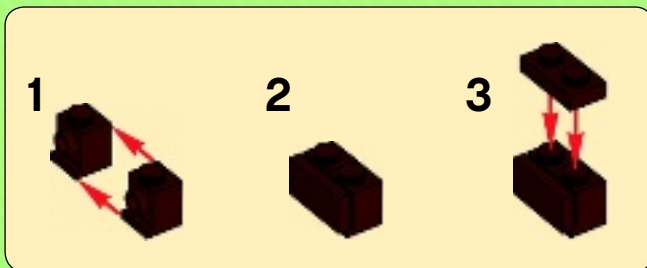



2x

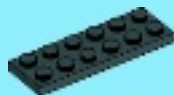

1x

41



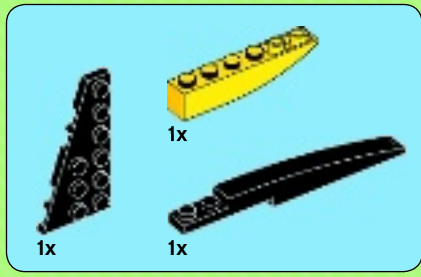

42

1



2



3

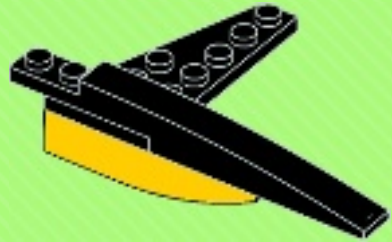

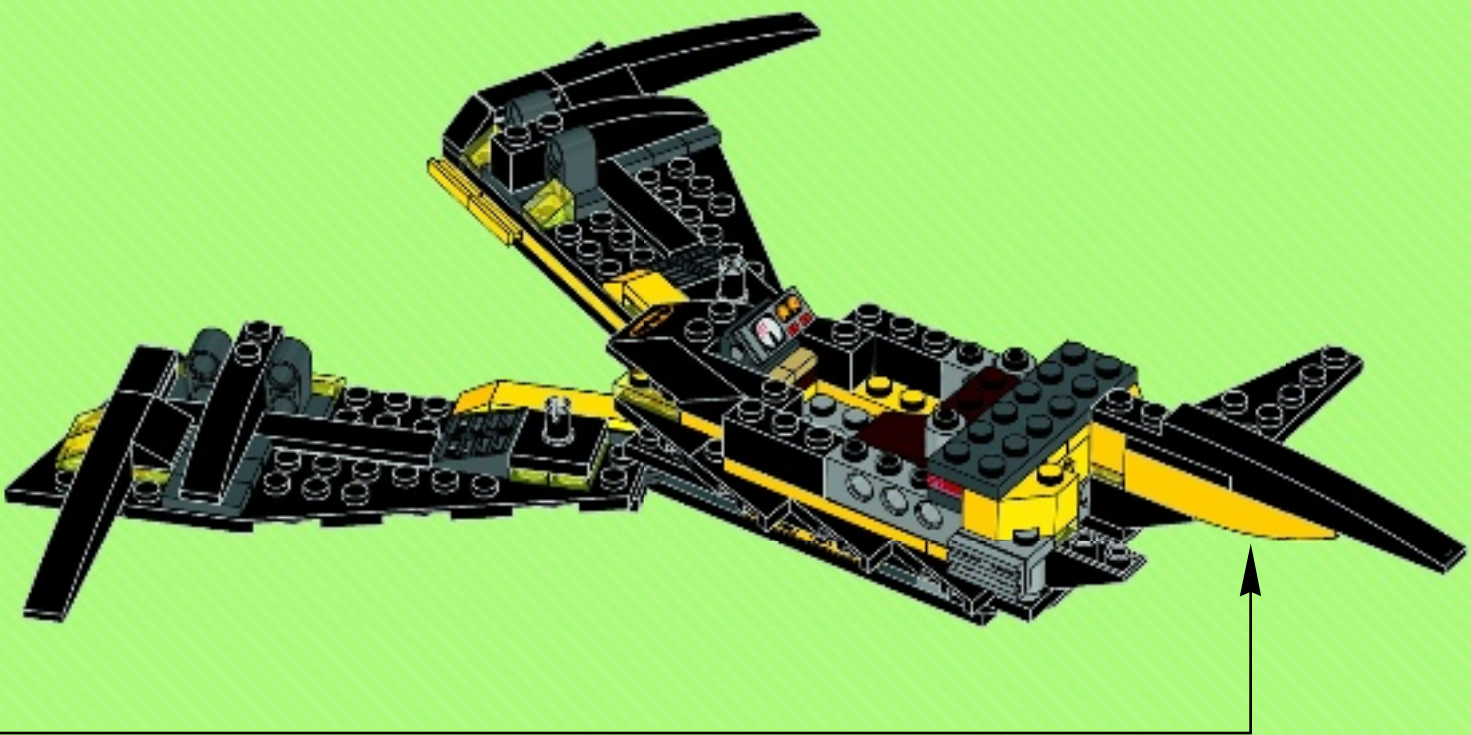

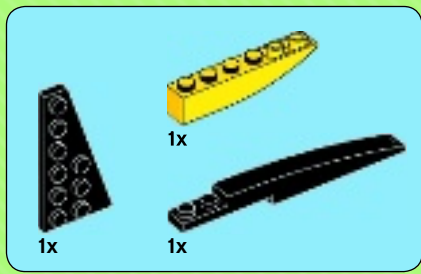

43

1



2



3



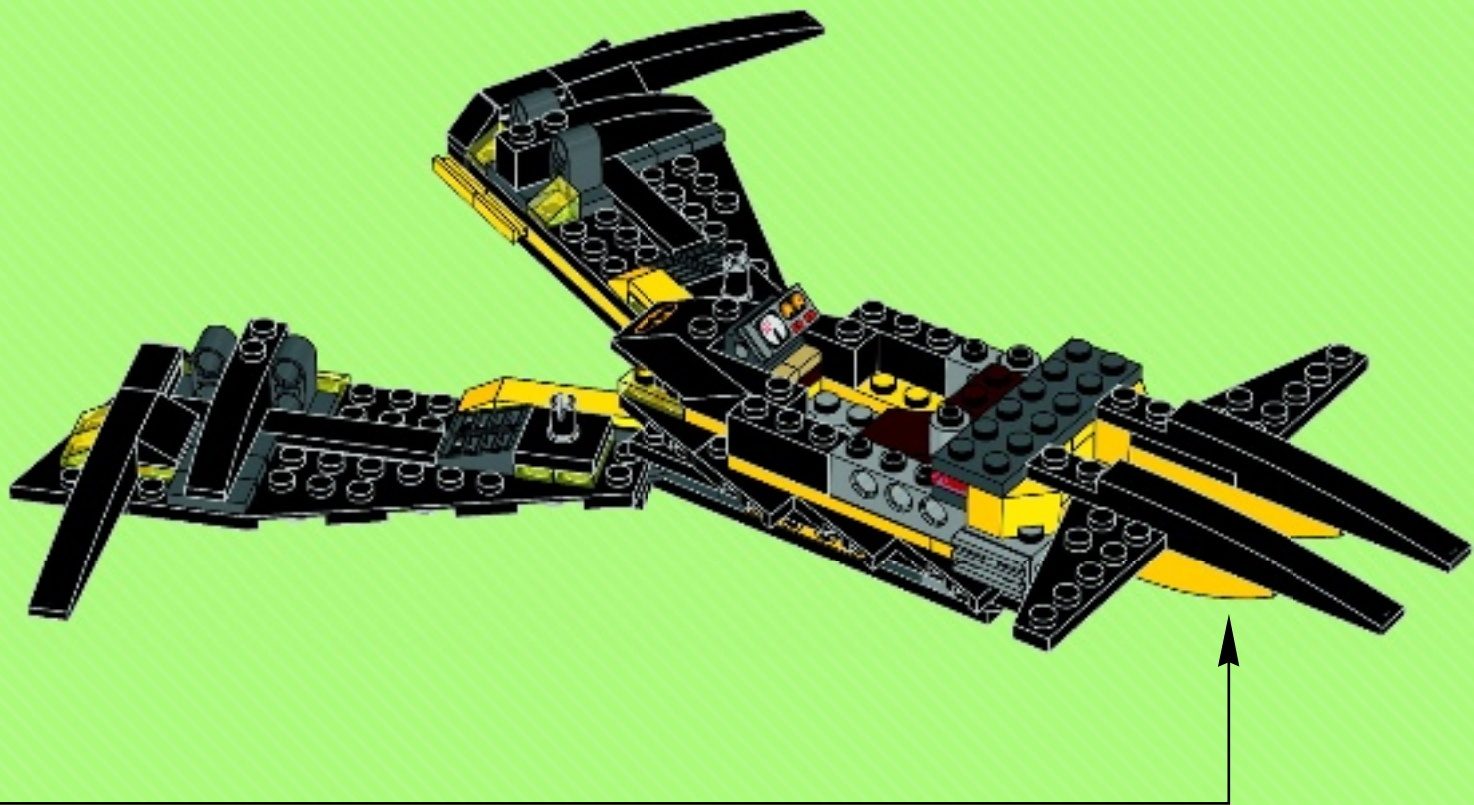



2x



2x



2x

44

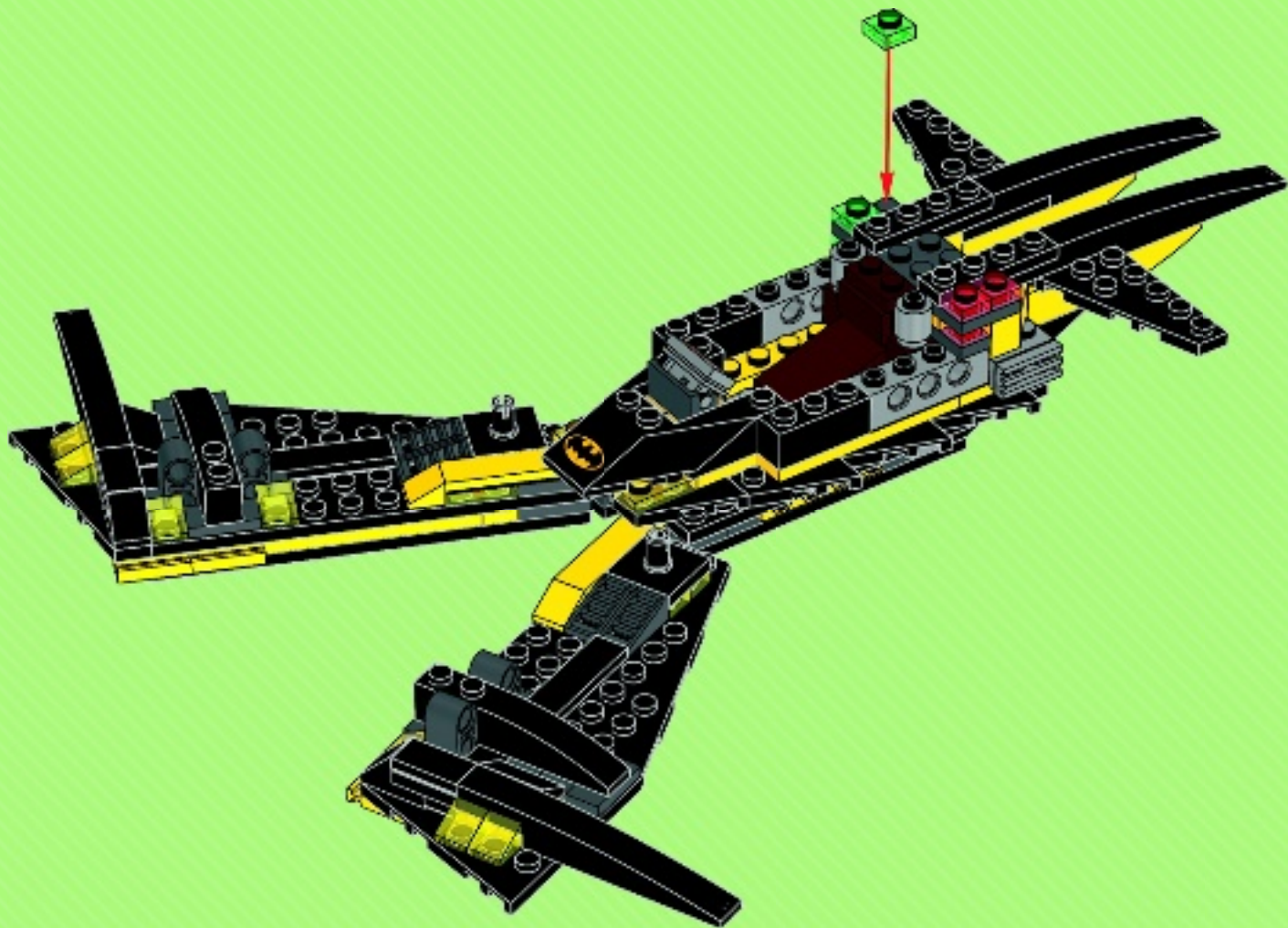



2x

45





46





1x



2x

47





4x

48





49

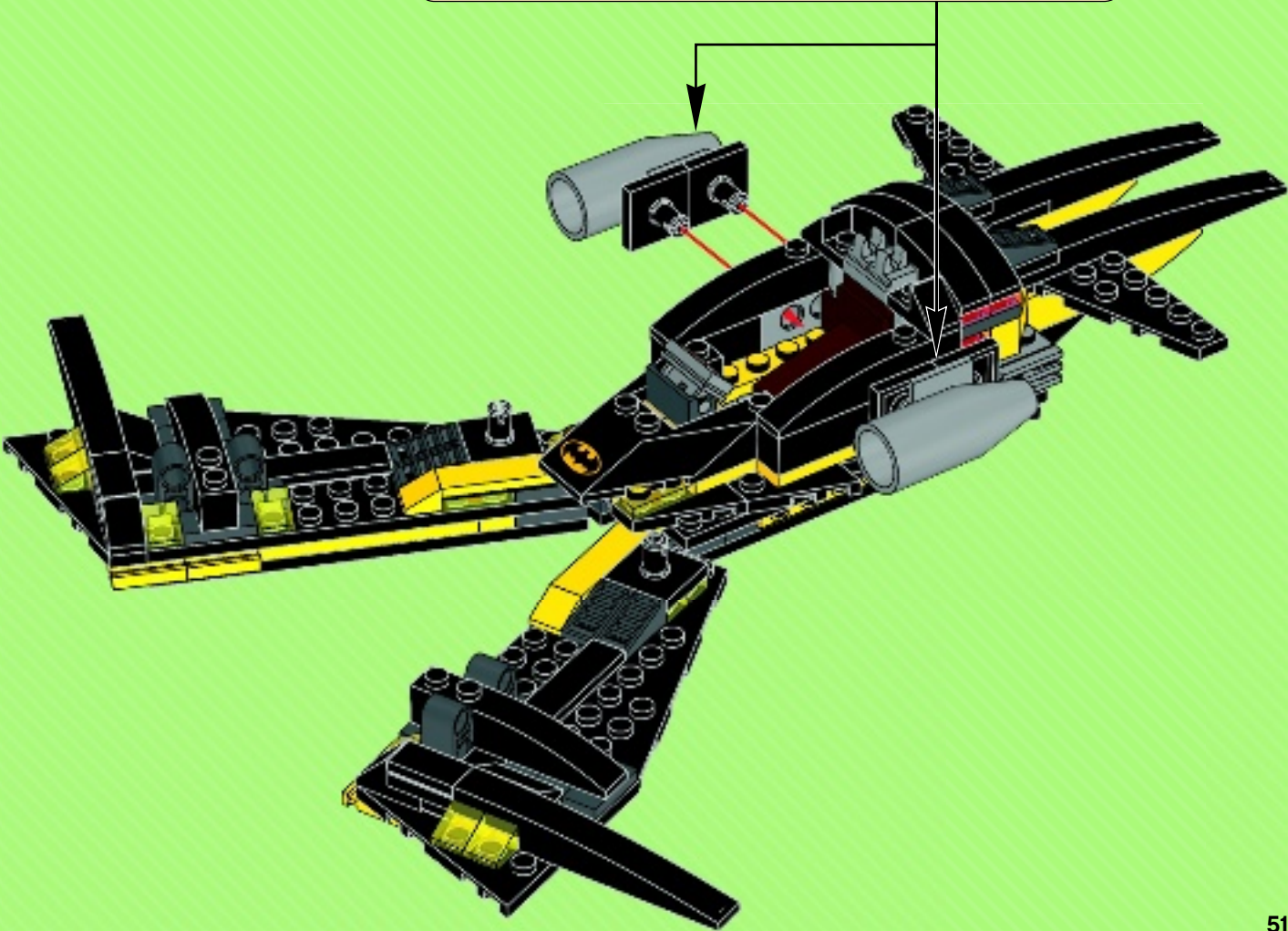
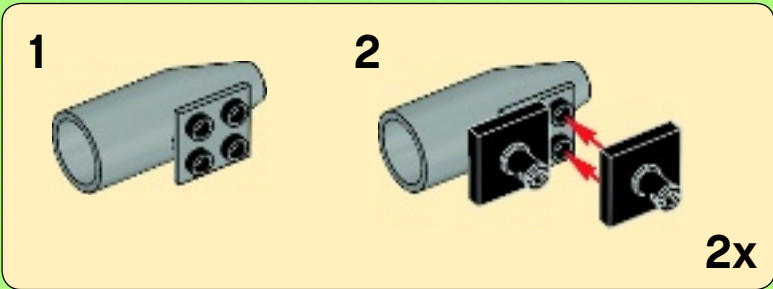



2x



1x

50

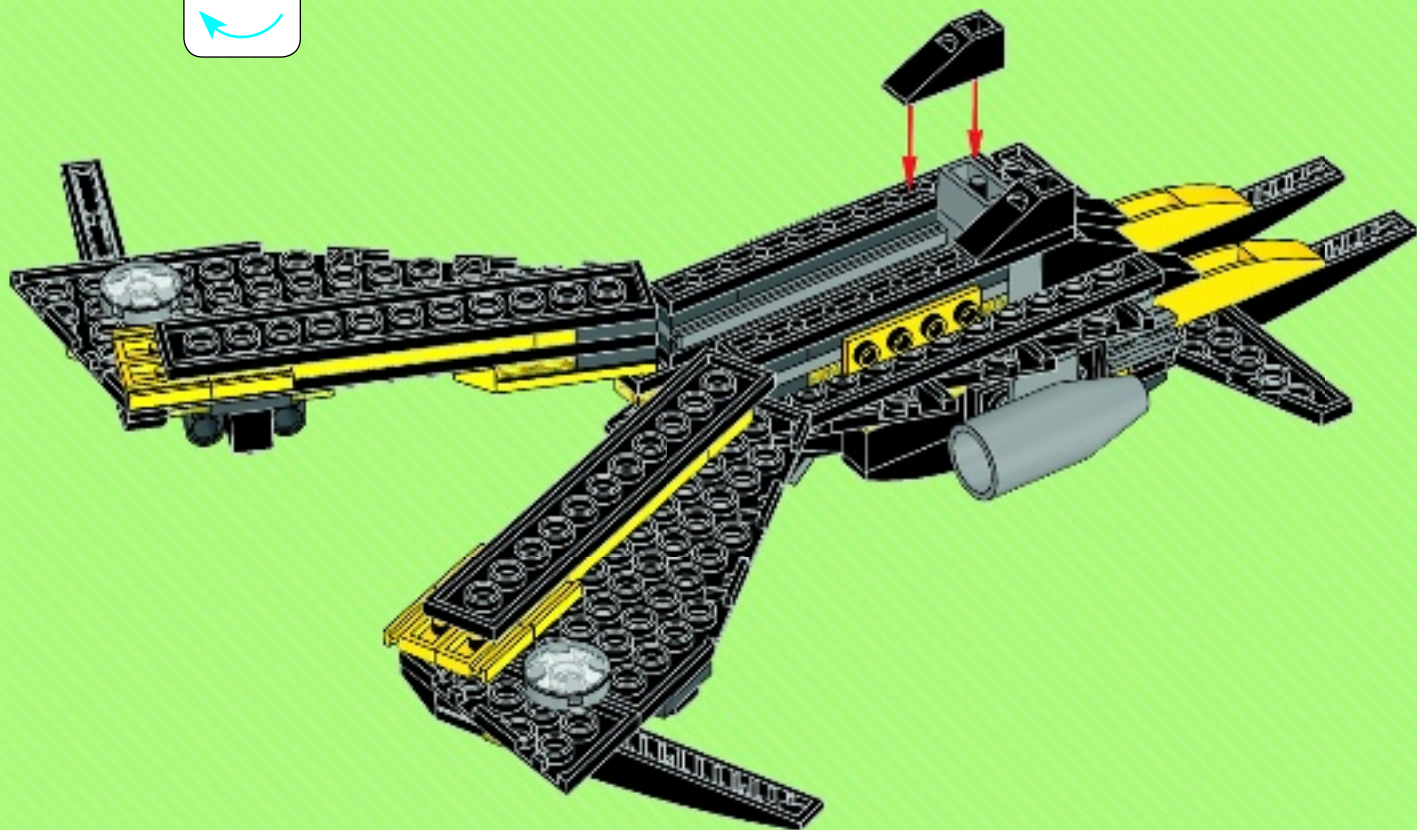



2x



4x

51

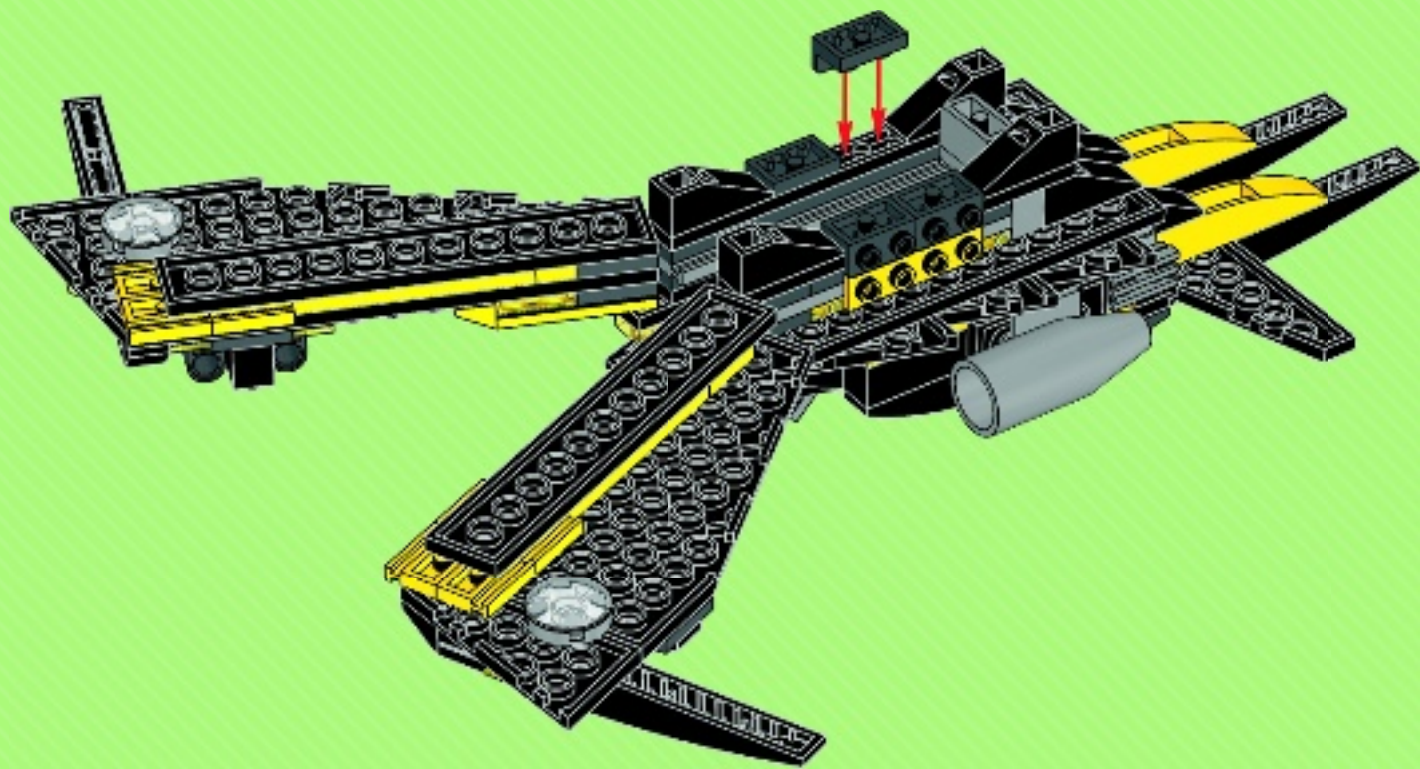



2x

52

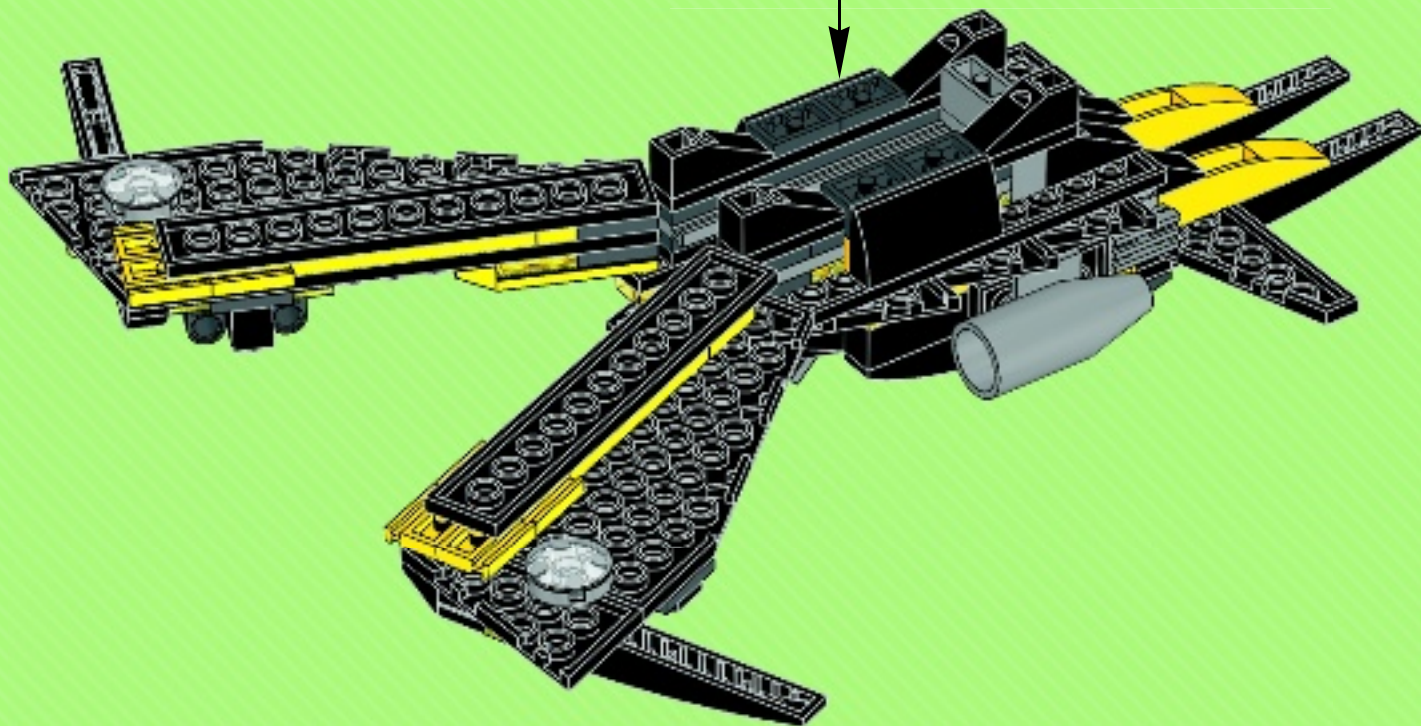

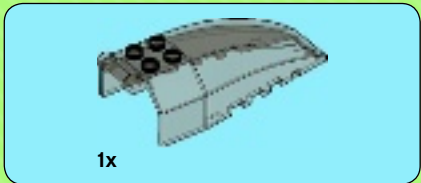

53

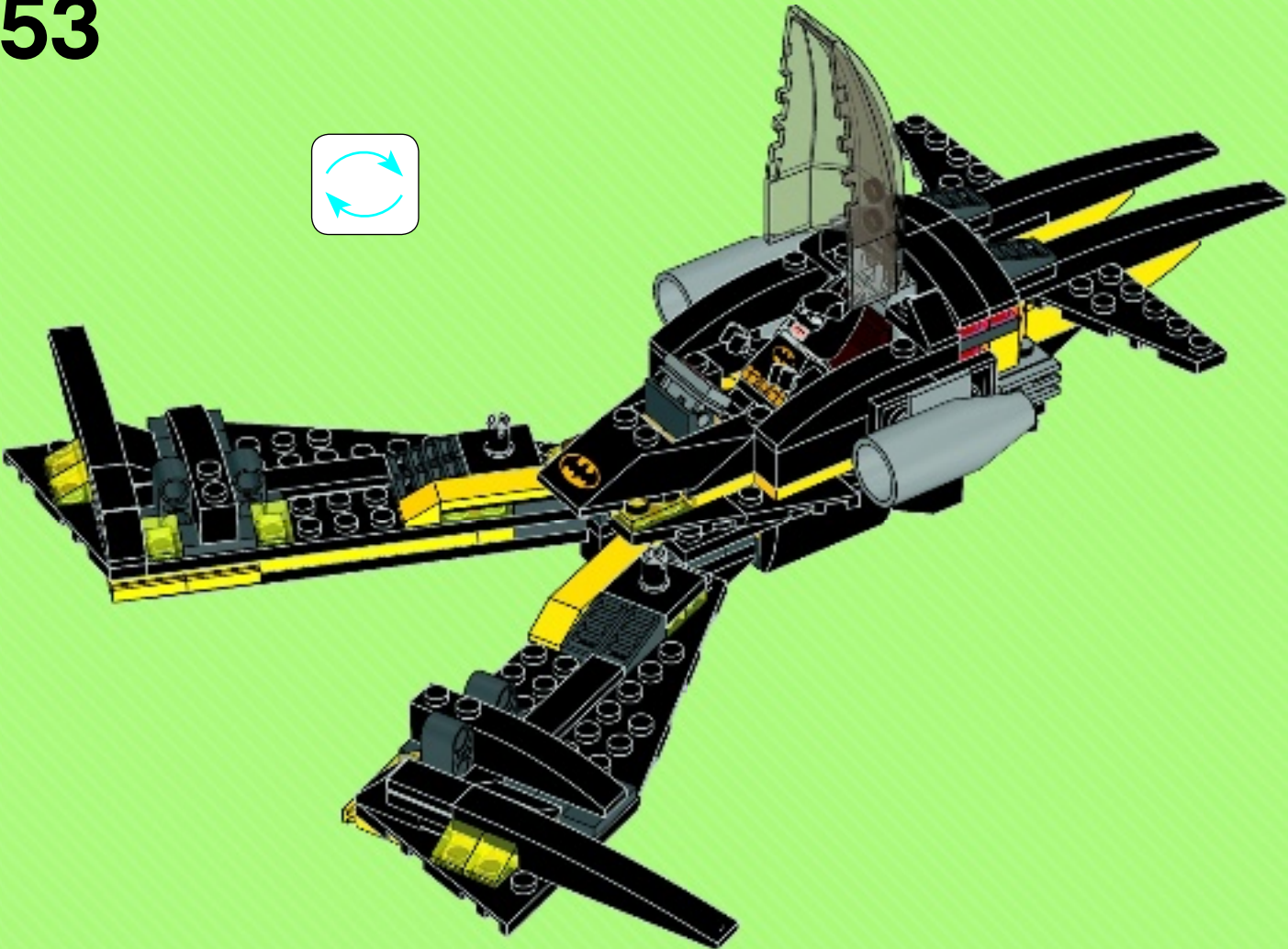

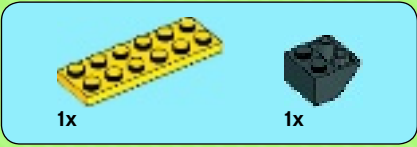
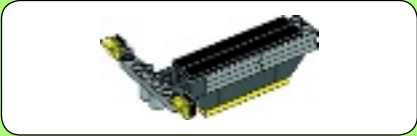

1

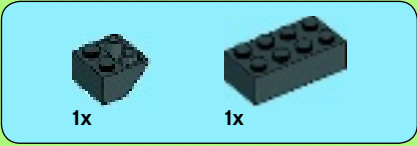
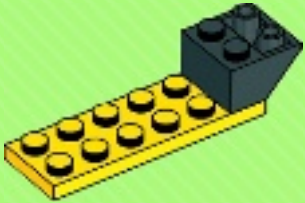

2

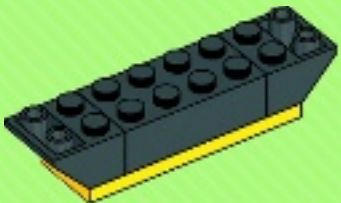

3

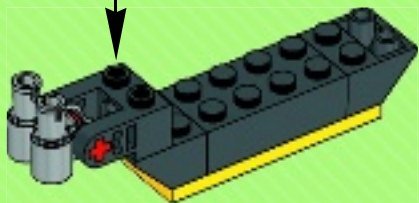
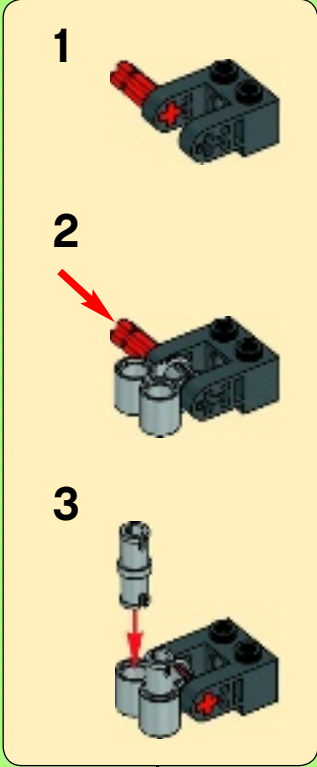



4x

4

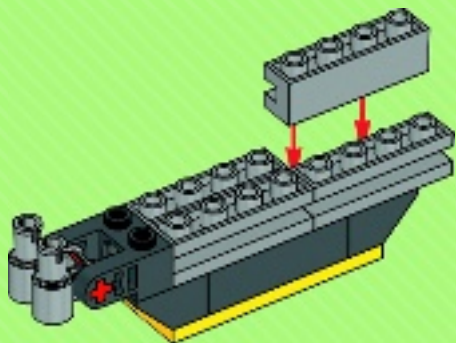

2x

5

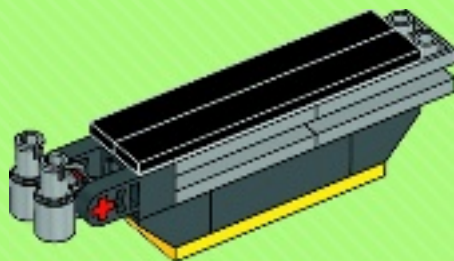

1x

6

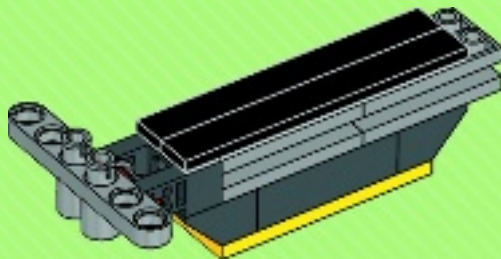



1x



1x

7

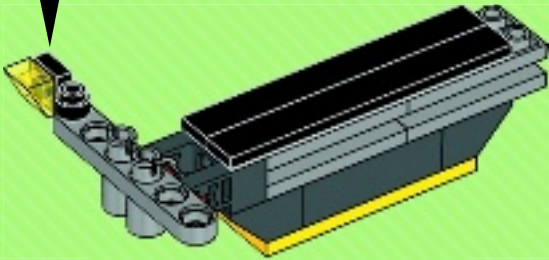

1x



1x

8

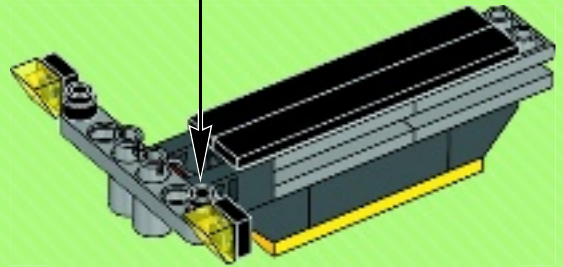

54

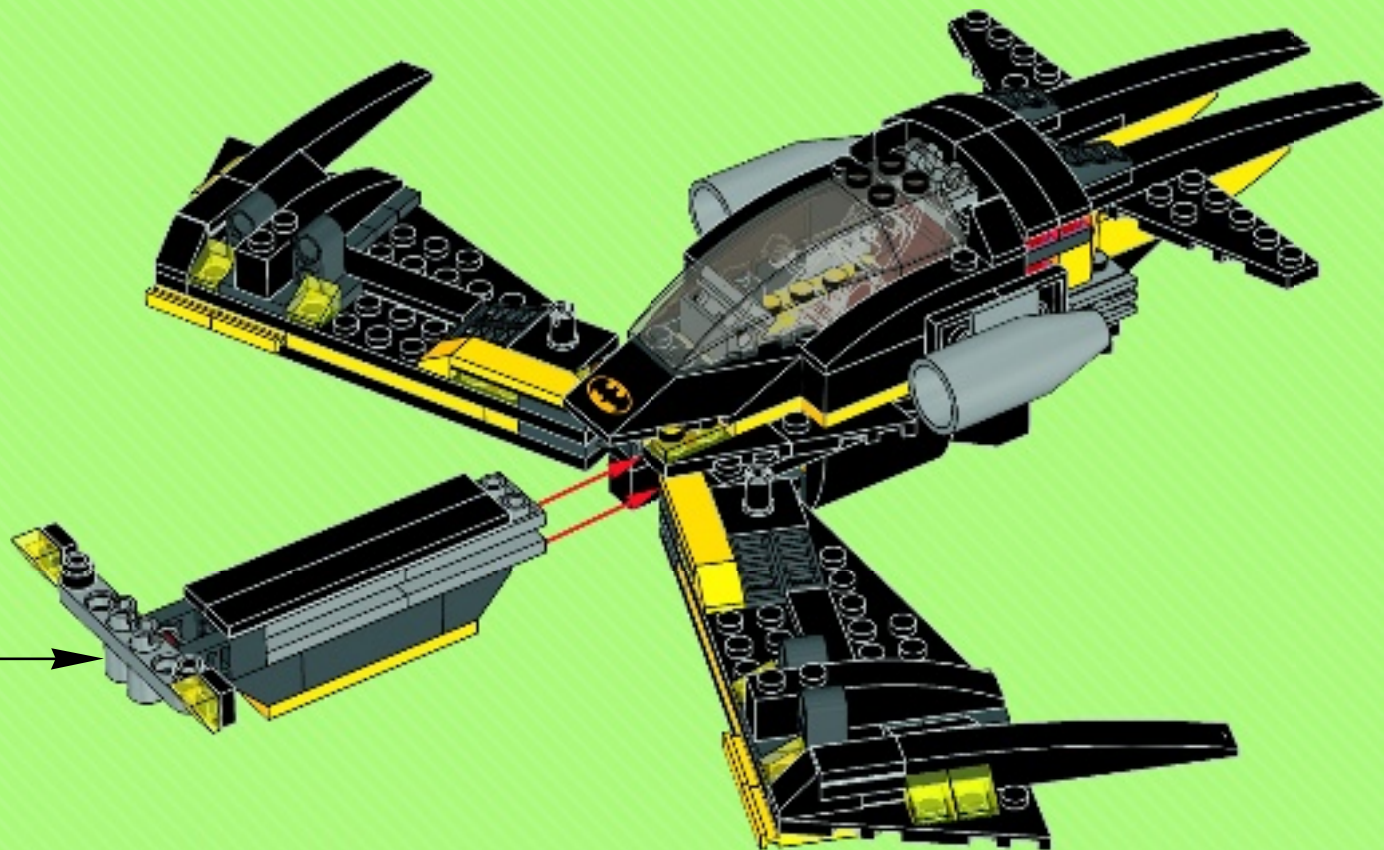



2x

55



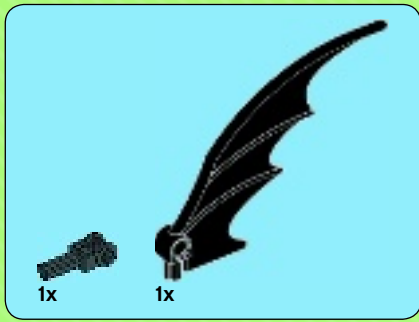

56

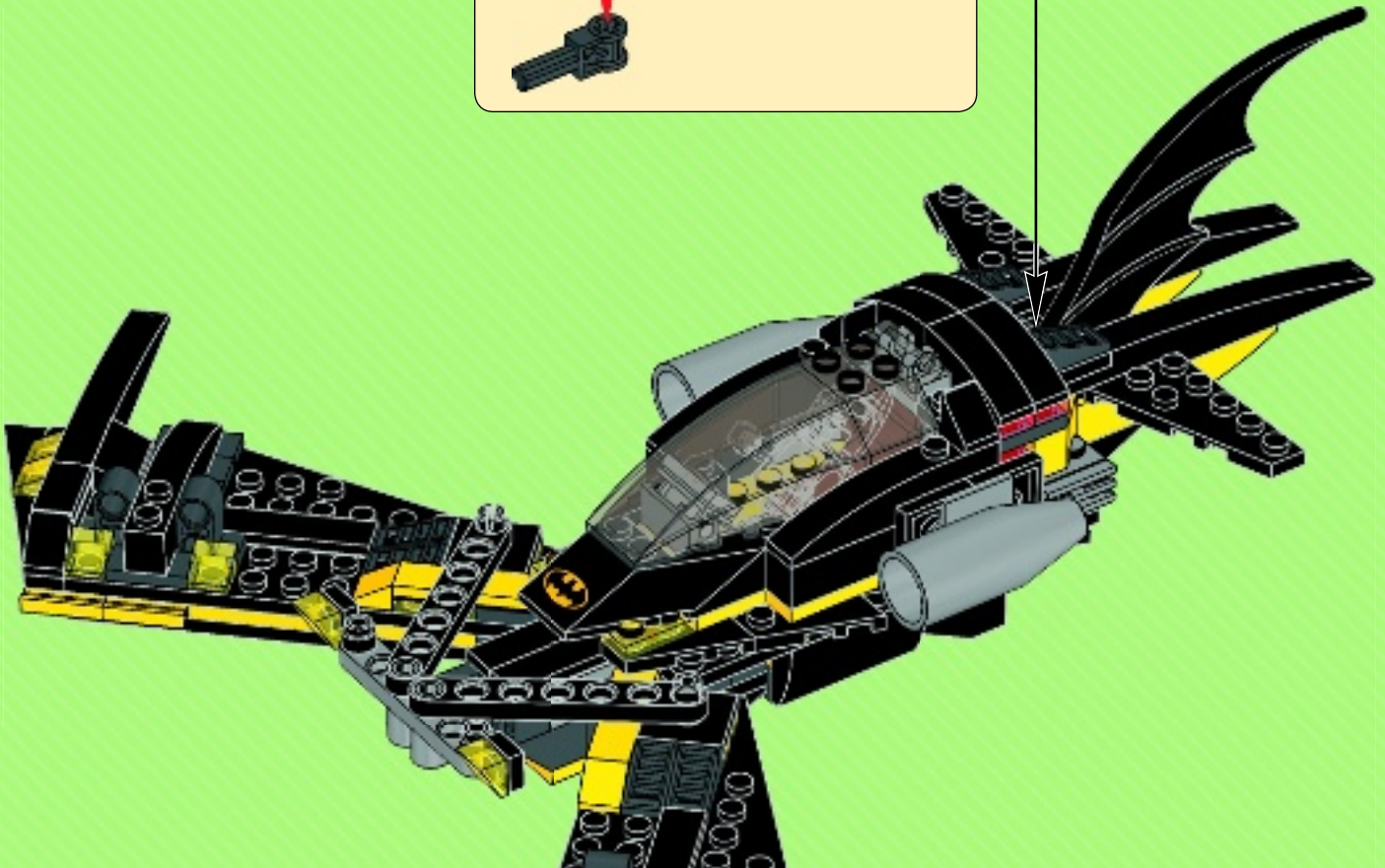



4x



4x

57

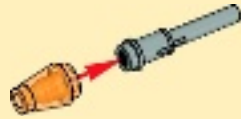

4x

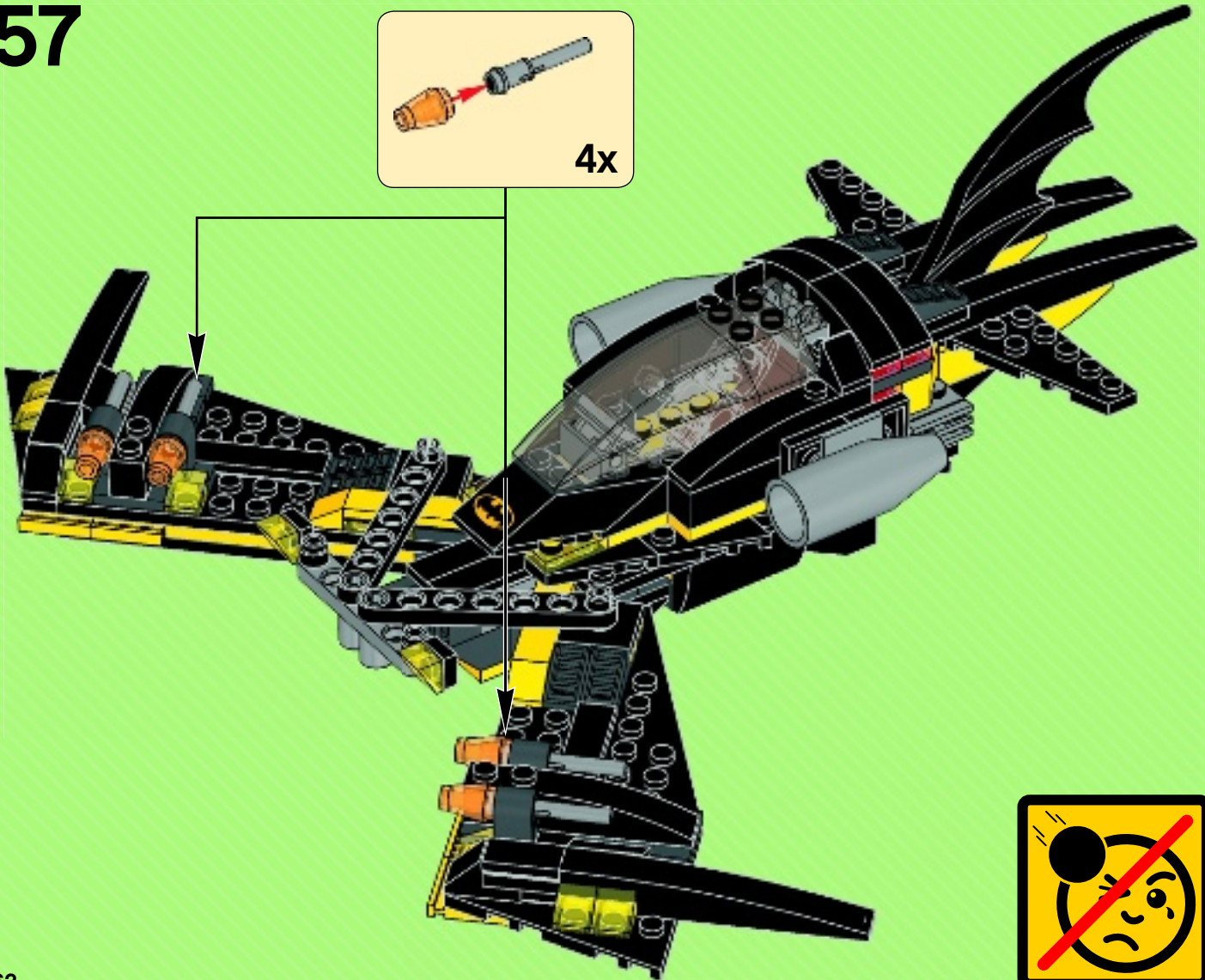





WIN!

Go to LEGO.com/productfeedback to fill out a survey for a chance to win a cool LEGO® Product. No purchase necessary. Open to all residents where not prohibited.



LEGO.com/productfeedback

GEWINNE! WIN!

Nimm an der Umfrage auf LEGO.com/productfeedback teil und hab die Chance ein cooles LEGO® Produkt zu gewinnen!

Die Teilnahme am Gewinnspiel führt zu keinerlei Kaufverpflichtungen. Teilnahme in allen nicht ausgeschlossenen Ländern möglich.

Ga naar LEGO.com/productfeedback, vul een enquêteformulier in en maak kans op een cool LEGO® product.

Geen aankoopverplichting. Ledereen mag deelnemen, uitgezonderd ingezetenden van landen waar een enquêteverbod geldt.

GAGNE! 当てよう!

Visite LEGO.com/productfeedback pour répondre à un questionnaire et avoir une chance de gagner un produit LEGO® très cool!

Aucune obligation d'achat. Ouvert à tous les résidents des pays autorisés.

LEGO.com/productfeedback にアクセスして、アンケートにご記入ください。当選者にはレゴ®製品を差し上げます。

お買い上げの必要はありません

禁止されていない限り、すべての皆様にご利用いただけます。



6070946



BATMAN and all related characters and elements are trademarks of and © DC Comics. Les marques de commerce et les copyrights de BATMAN et de tous les personnages et éléments qui y sont liés appartiennent à © DC Comics. Las marcas comerciales y © vinculados a BATMAN y todos los personajes relacionados son propiedad de DC Comics.



WB SHIELD: TM & © Warner Bros. Entertainment Inc. (s14)

LEGO and the LEGO logo are trademarks of the/son des marques de commerce de/son marcas registradas de LEGO Group. ©2014 The LEGO Group.