



SCOOBY-DOO!

75902



[LEGO.com/scoobydoo](https://www.LEGO.com/scoobydoo)





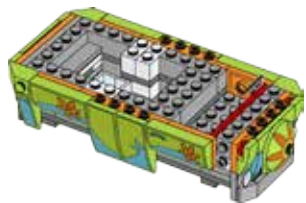

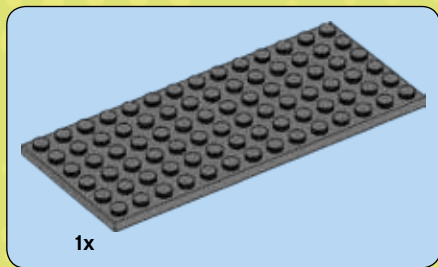

1

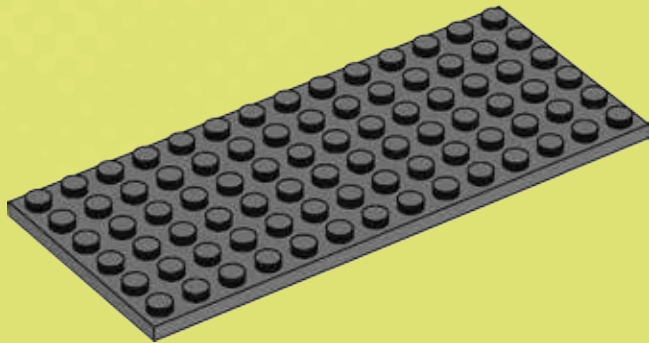



2

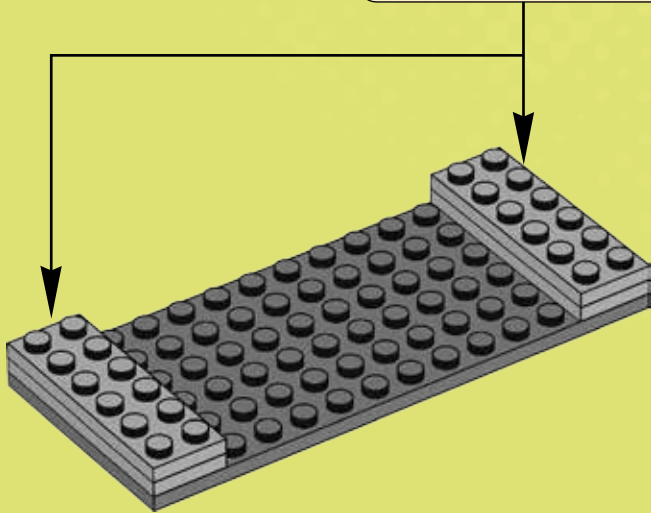
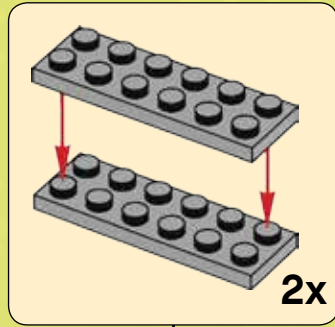



2x

3

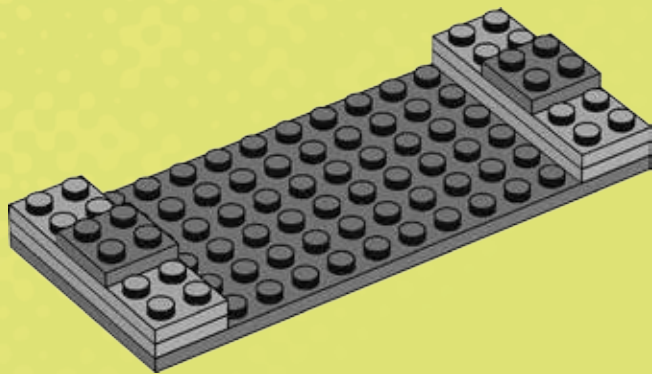

6



4x

4

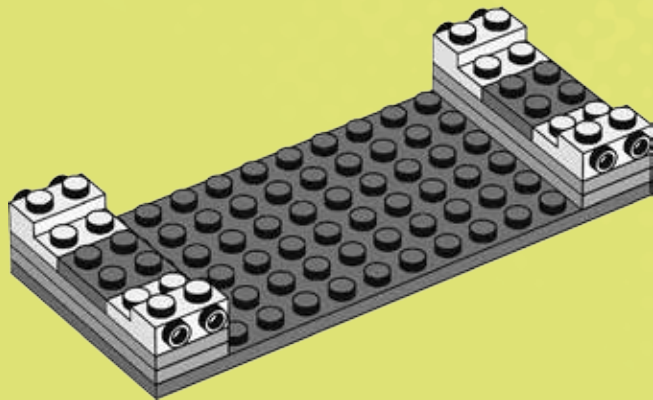



2x

5

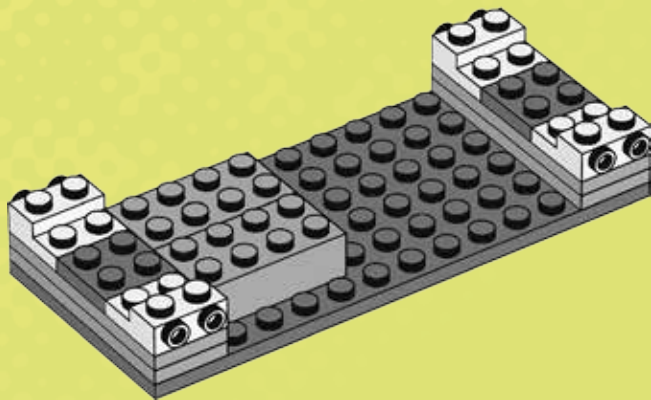

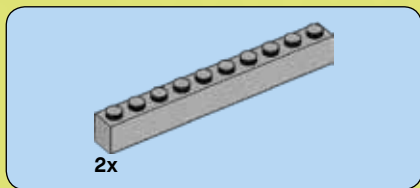

6

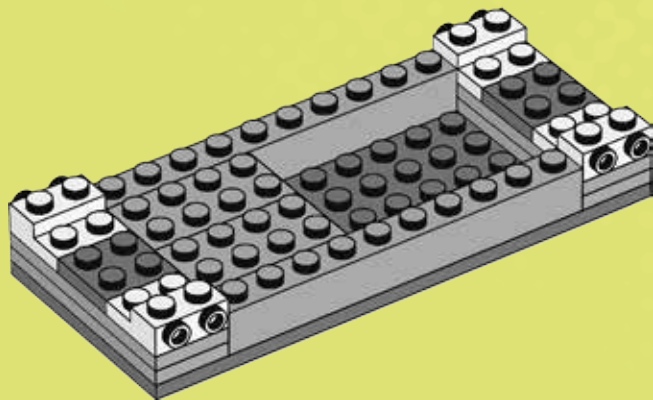



4x

7

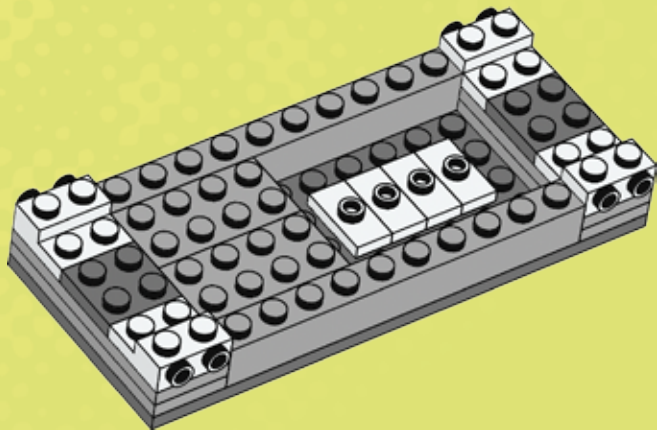



2x

8

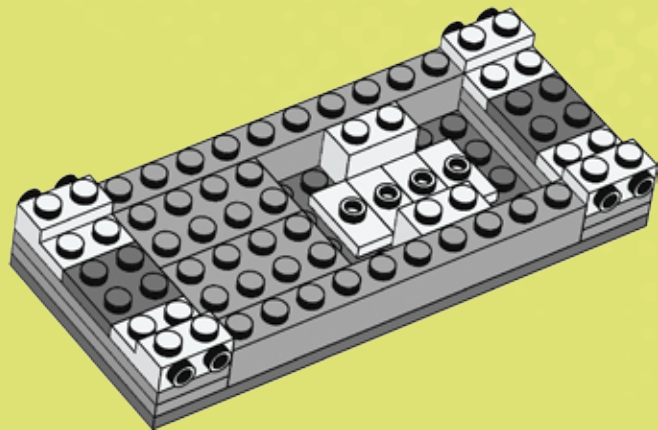



1x



2x

9

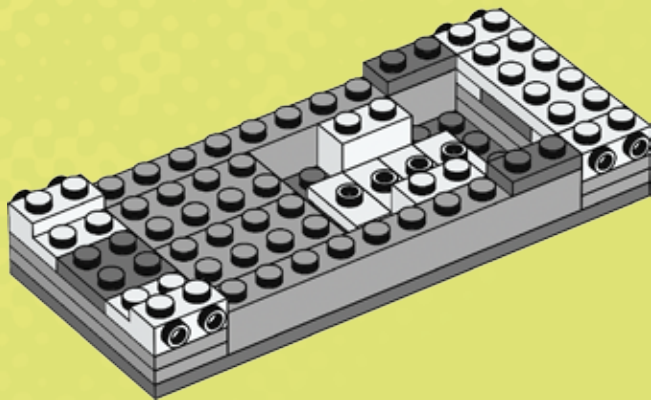



2x



2x

10

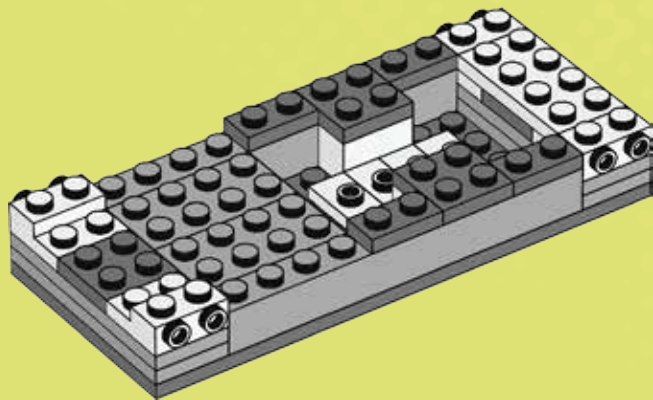



2x



1x

11

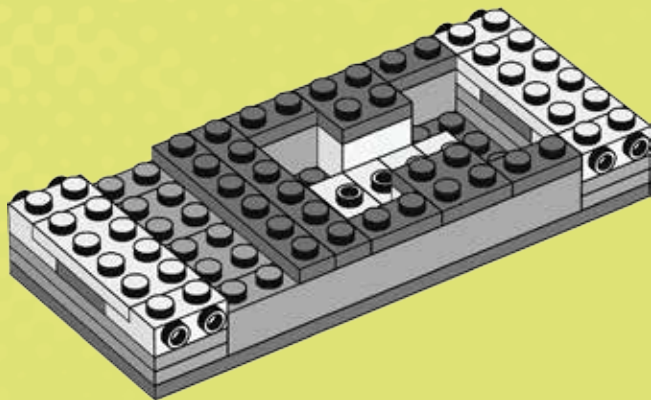

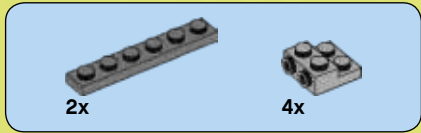

12

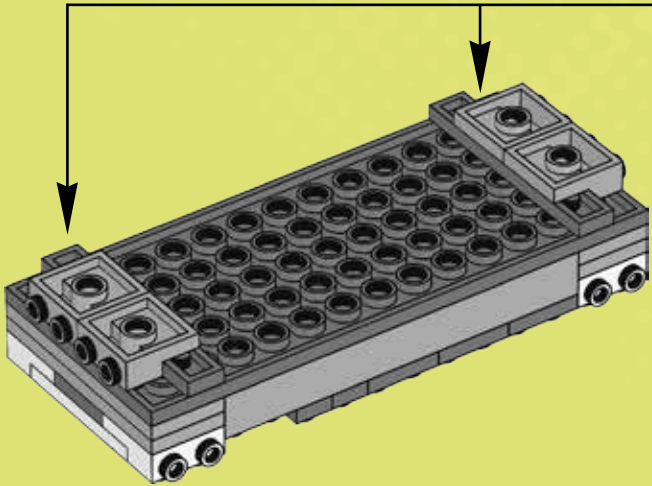
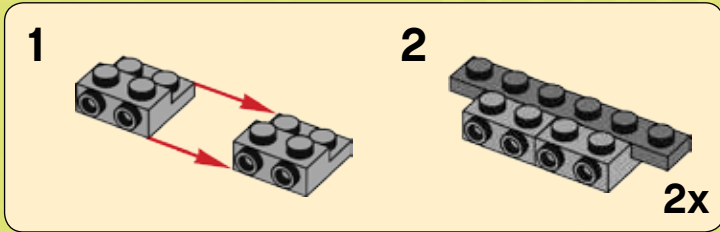



1x



1x

13

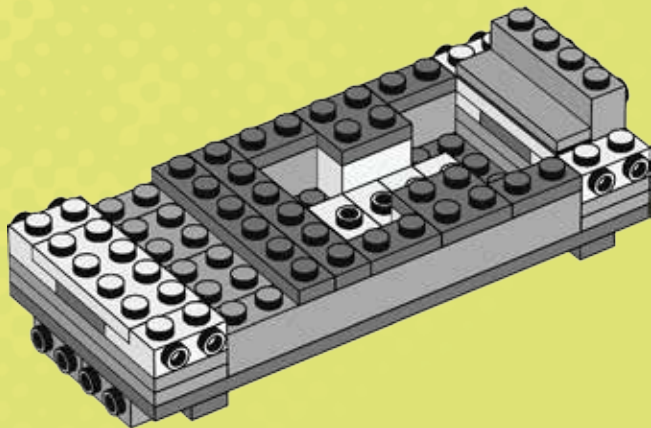



2x

14

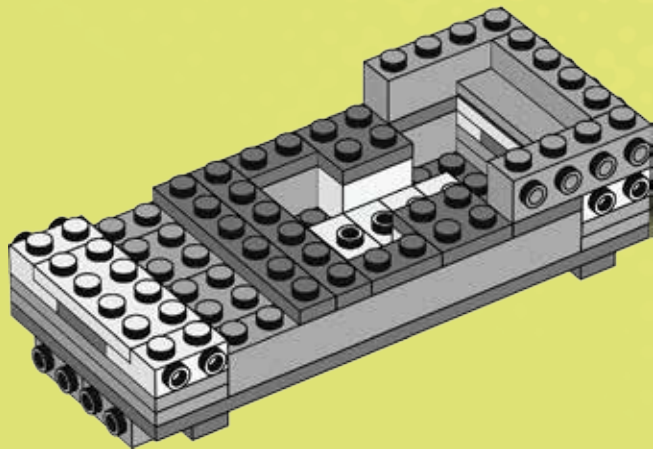



3x



2x

15

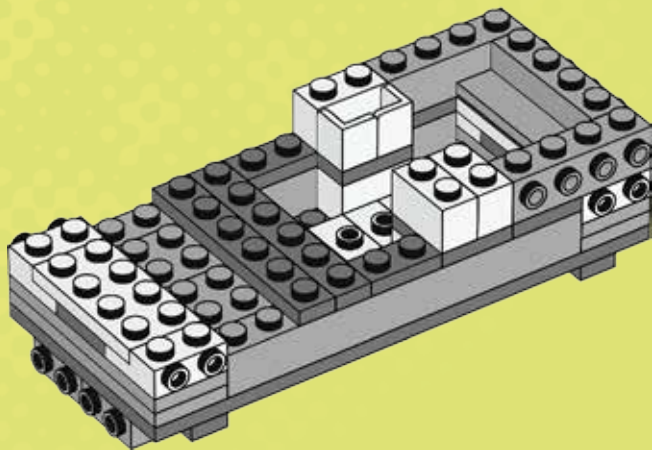



1x



2x

16

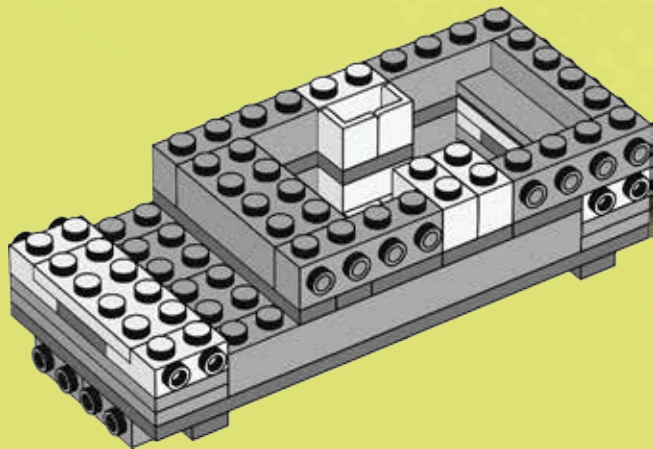



1x



1x

17

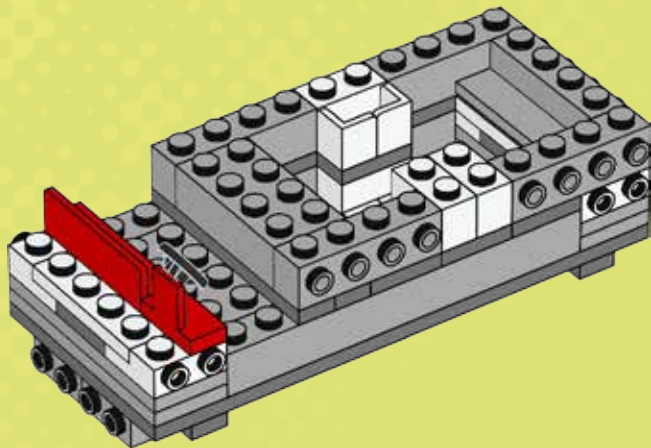



1x



2x

18

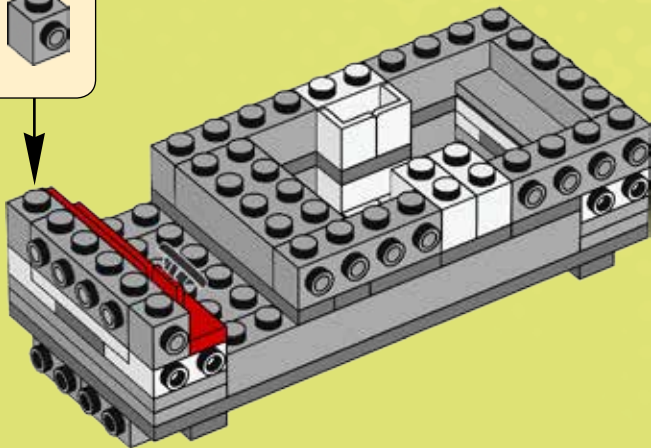

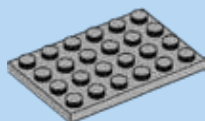

1x

1



1x

2

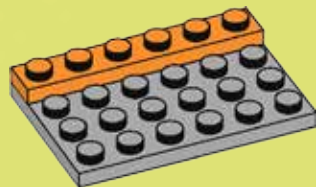

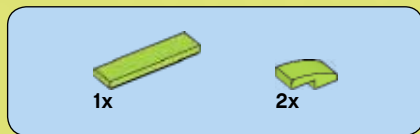

3



4

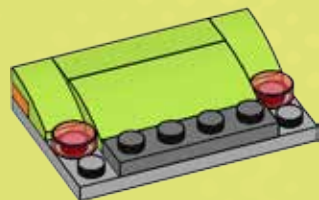



1x



2x

5

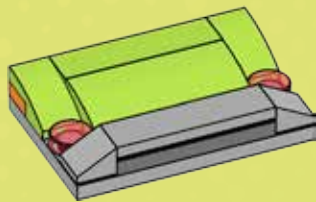

19

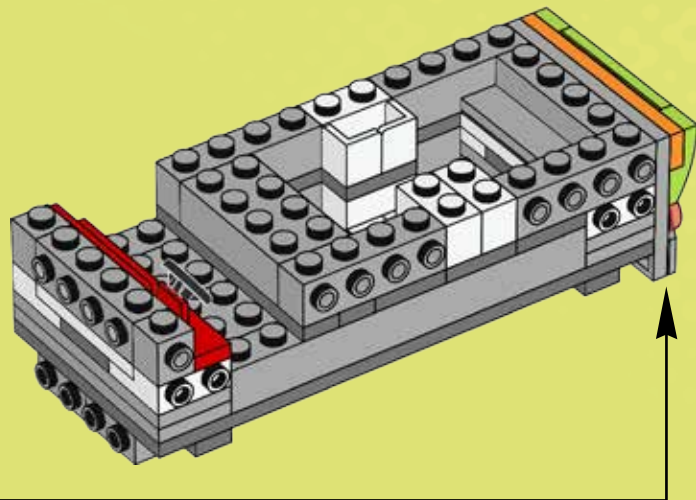

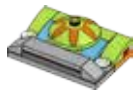

1x

1



4x



1x

2





1x



2x

3

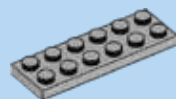
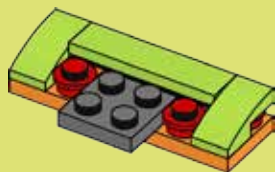

1x

4

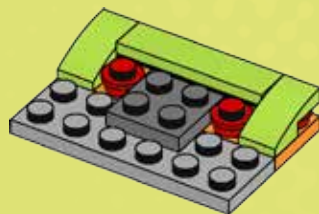



2x



2x

5



1x



1x



1x

6

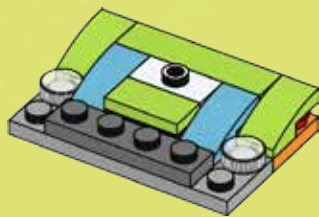

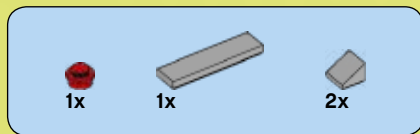

7

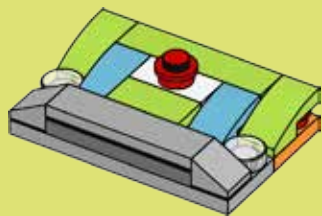

8

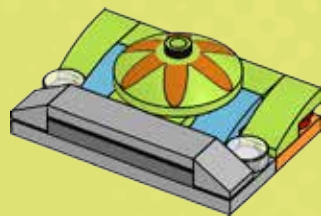

20

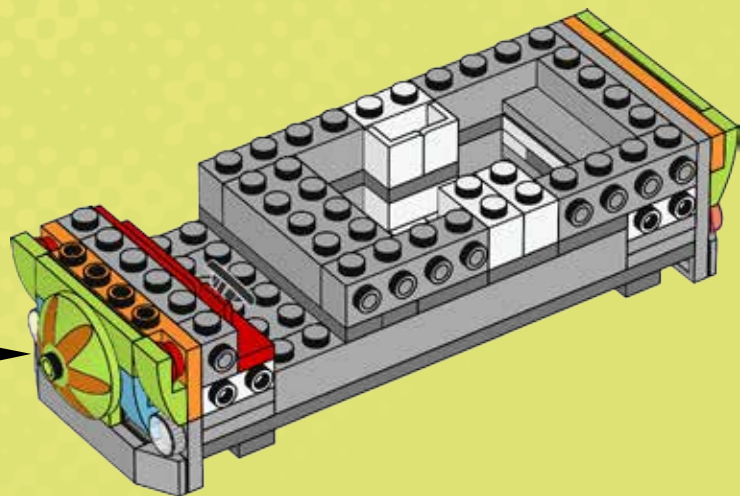

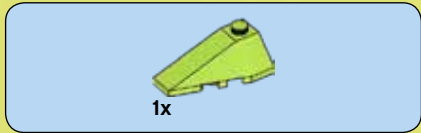

21

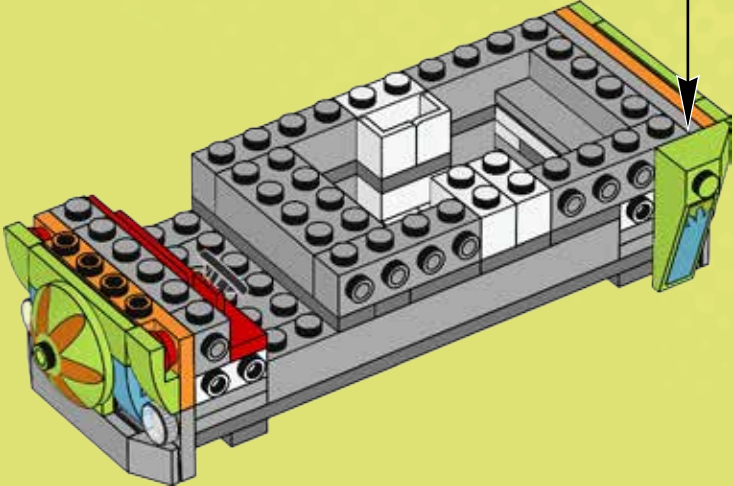
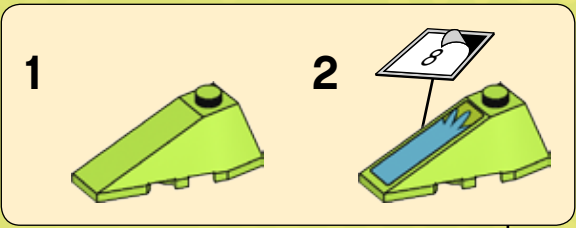

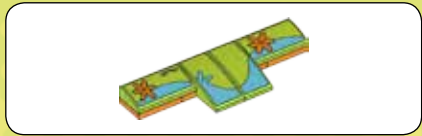

1

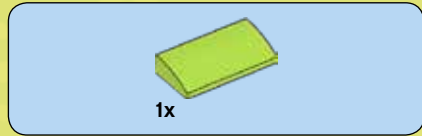

2

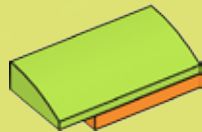



1x

3

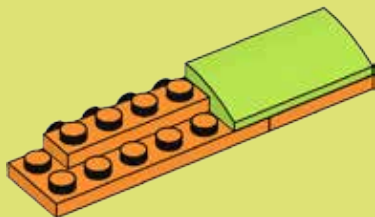

2x

4

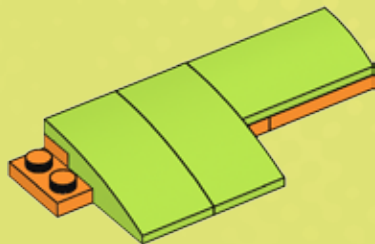



1x

5

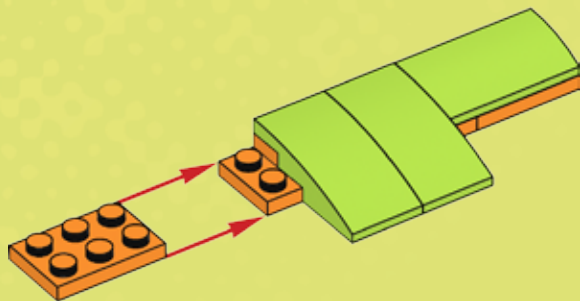

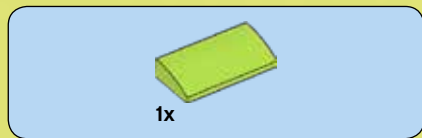

6

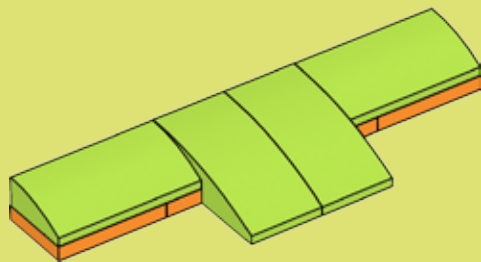

7

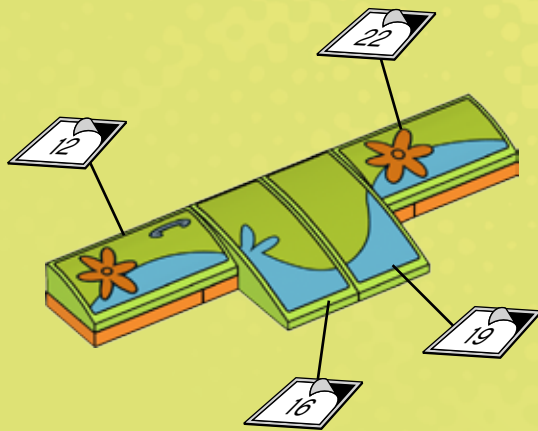

22

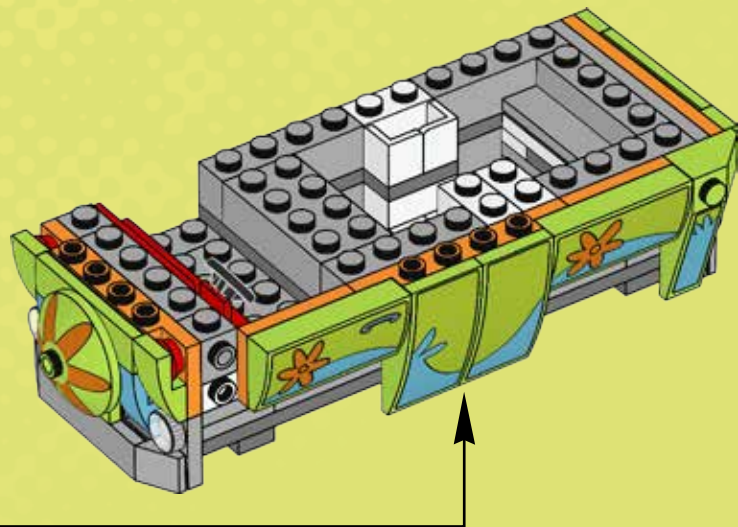



1x

23

1

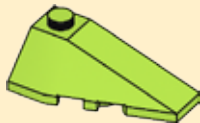

2

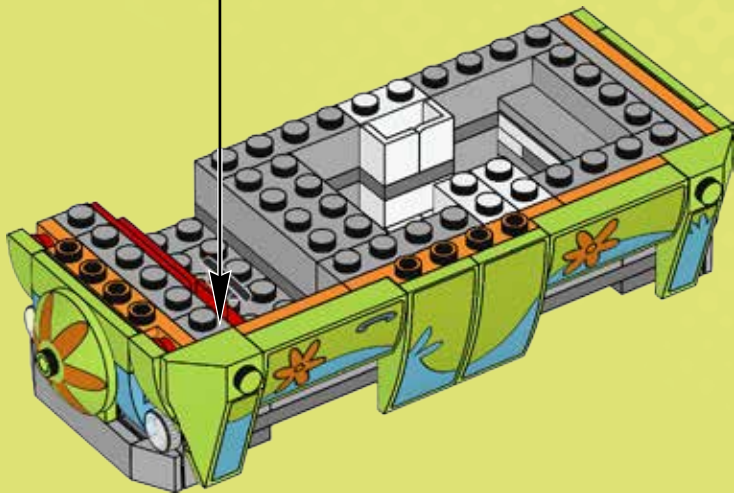



1x

24



1

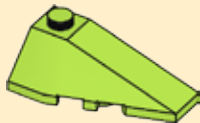

2

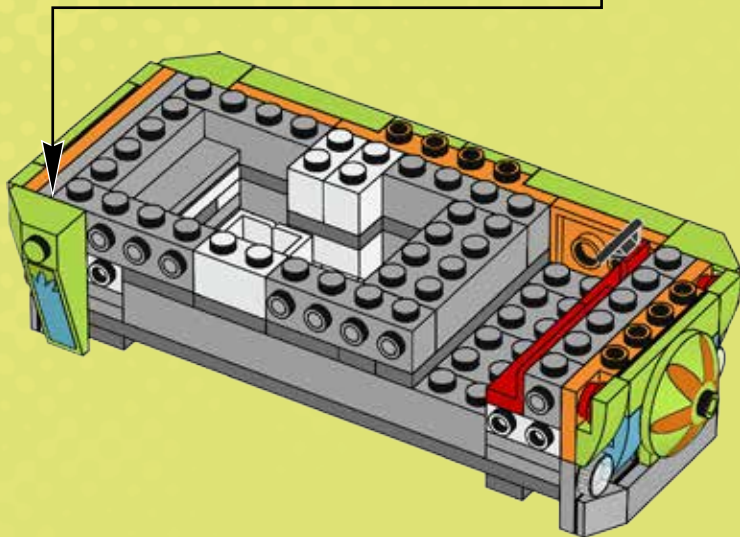
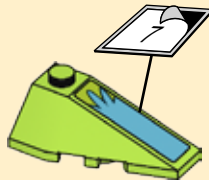

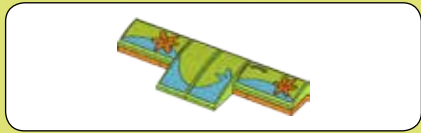

1

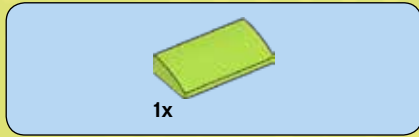

2





1x

3

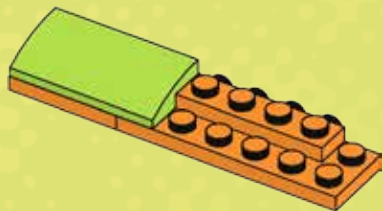

2x

4

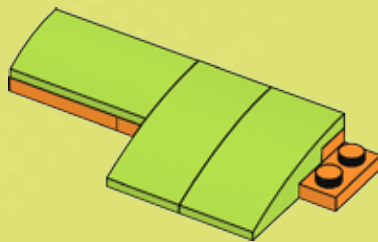



1x

5

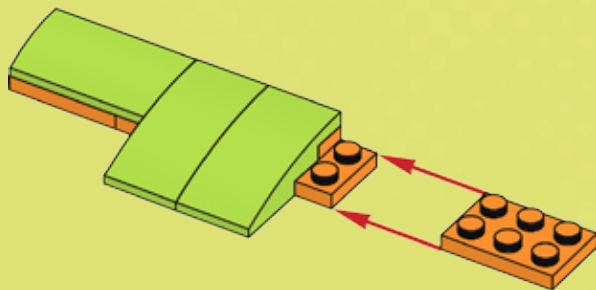

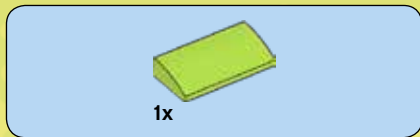

6

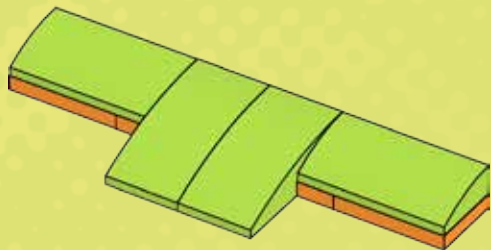

7

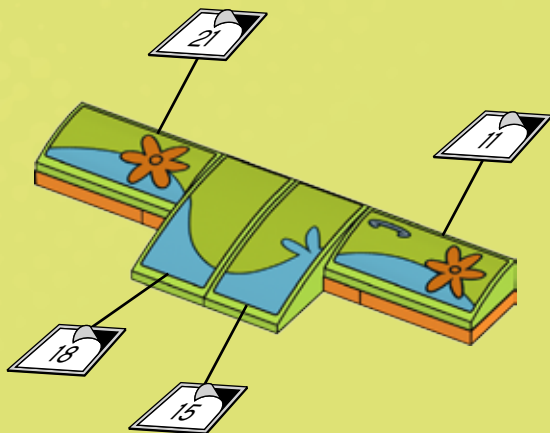

25

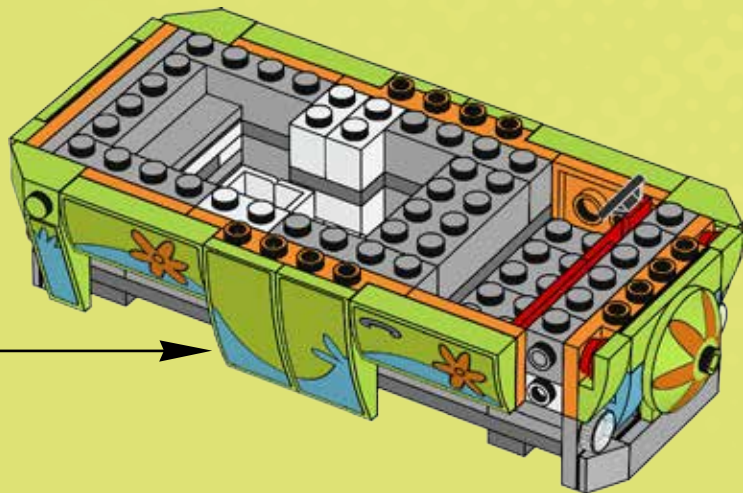

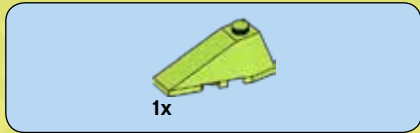

26

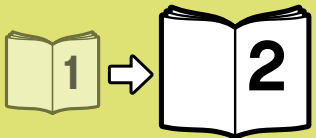
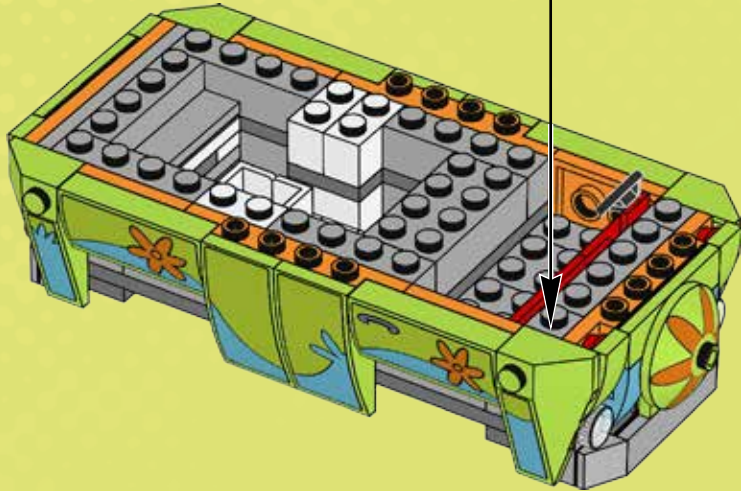
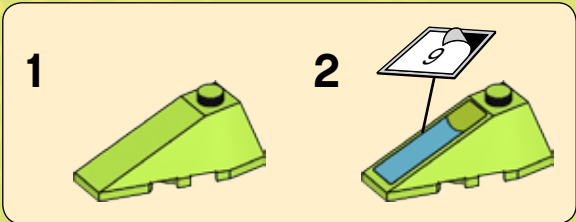



SCOOBY-DOO!

WE'VE GOT A MYSTERY TO SOLVE
NOUS AVONS UN MYSTÈRE À RÉSOUDRE
TENEMOS UN MISTERIO QUE RESOLVER

75900



75901



75902



75903



75904



LEGO.COM/scoobydoo





More spooky fun at
LEGO.com/scoobydoo
Plus d'amusement effrayant sur
LEGO.fr/scoobydoo
Más diversión tenebrosa en
LEGO.com/scoobydoo



SCOOPY-DOO!



Apple, the Apple logo, iPad, iPhone and iPod touch are trademarks of Apple Inc. Apple, le logo Apple, iPad, iPhone et iPod touch sont des marques de commerce d'Apple Inc. Apple, el logotipo de Apple, iPad, iPhone e iPod touch son marcas comerciales de Apple Inc. Google Play is a trademark of Google Inc. Google Play est une marque de commerce de Google Inc. Google Play es una marca comercial de Google Inc.



DC COMICS
**SUPER
HEROES**

76034

**SUPER
JUMPER**



76035



DC COMICS™



BATMAN and all related characters and elements are trademarks of and © DC Comics/BATMAN et tous les personnages et éléments qui y sont associés sont des marques de commerce et © de DC Comics/BATMAN y todos sus personajes y elementos relacionados son marcas y © de DC Comics.



WB SHIELD: TM/MC & © Warner Bros. Entertainment Inc. (s15)